

Dairy Solutions Catalog

2020
Catalog

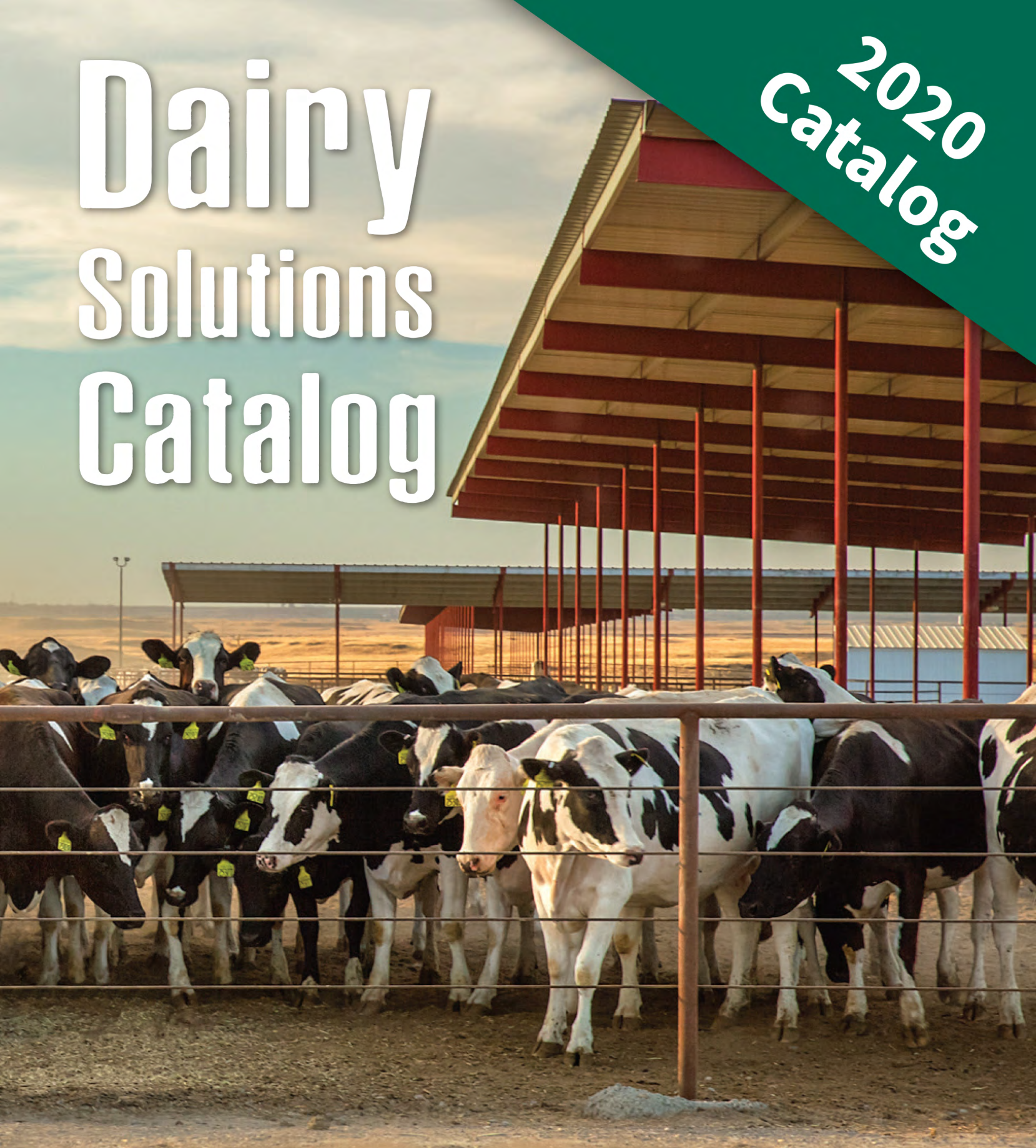



Table of Contents

Reproduction

Page 4

Genomics	5-8
Breeding Diagnostics	9
Semen Collection	10-11
Breeding Supplies	12-13
Calving Supplies	14-17
Apparel.....	18-21

Dairy Hygiene

Page 22

Cleaners & Disinfectants	23-25
CIP (Clean-In-Place) & Bulk Tank Cleaners.....	25-26
Acid Detergents	27
Teat Dips & Udder Washes	27-29

BioSecurity

Page 30

Insect Control	31-39
Rodent Control	40-48
Specialty Disinfectants.....	49

Health & Wellness

Page 50

Water Treatment.....	51-52
Disease Diagnostics.....	52-53
Calf Care.....	54-56
Oral Treatments & Drenching	57-59
Needles & Syringes.....	60-70
Wound & Surgical Supplies.....	71-73
Castration & Dehorning.....	74-75
Hoof Care	76-81
Handling & Identification.....	82-91

Parlor Supplies

Page 92

Udder Health	93-97
Milk Filters.....	98-101
Towels.....	102-103
Protective Wear & Apparel	104-114
Barn Tools.....	114-129
Milk Testing.....	130-131

Small Ruminant

Page 132

Small Ruminant.....	133-135
---------------------	---------



NEOGEN Corporation develops, manufactures, and markets animal and food safety solutions.

NEOGEN (NASDAQ: NEOG), founded in 1982, has grown to 1,820 employees in multiple U.S. and international locations. NEOGEN has been repeatedly named one of Forbes Magazine's best small companies in America, and is in NASDAQ's top tier of companies—its Global Select Market. For more about NEOGEN, please visit **NEOGEN.com**.

Animal Safety

NEOGEN's products include:

Veterinary Performance and Companion Animal Products

NEOGEN's biological line includes BotVax[®] B, the only USDA-approved vaccine against equine botulism type B; EqStim[®], an effective USDA-approved immunostimulant for adjunctive treatment of equine respiratory disease complex; and UNIPRIM[®], a popular veterinary antibiotic.

Veterinary Instruments and Supplies

NEOGEN offers affordable precision veterinary instruments and supplies. NEOGEN's extensive line of durable and disposable instruments is convenient and dependable. We offer products from needles and syringes, to breeding and delivery.

Rodent Control Products

NEOGEN's proven rodenticides are used for control of rodents and complement its disinfectants as a critical component of an overall biosecurity program. Rodents compromise the quantity and quality of food and feed, and spread disease.

Insect Control Products

NEOGEN's Prozap Insect Control products include well-known and proven insecticides that have a range of applications in the food and animal safety industries. NEOGEN's Catchmaster products offer non-toxic options for the home and farm.

Cleaners and Disinfectants

Animal facilities, from companion animal veterinary clinics to production livestock operations, benefit from Neogen's diverse range of cleaners and disinfectants. Neogen also offers step-by-step procedures to clean then disinfect numerous surface types of organic matter, biofilms and serum content. These products have broad germicidal capabilities to remove infectious agents, such as avian influenza.

Livestock and Canine Genomics

NEOGEN Genomics is a leading global provider of DNA testing and bioinformatics for animal protein and veterinary medicine through product lines such as Igenity and GGP.

Diagnostic Products

NEOGEN's tests detect more than 100 different drugs that may be considered drugs of abuse in racing and eventing animals, and residues in food animals.

Food Safety

The company's Food Safety Division markets dehydrated culture media and diagnostic test kits to detect foodborne bacteria, natural toxins, food allergens, drug residues, plant diseases and sanitation concerns. For more about Neogen's Food Safety Division, please visit foodsafety.neogen.com.

Reproduction

Genomics • Semen Collection • Breeding Supplies • Calving Supplies • Apparel



Reproduction

Genomics

Raising dairy heifers is the second highest expense on dairy farms with the initial investment still not returned well into the second lactation.

Genomic testing helps you make the best decisions for the future by providing estimates of the true genetic potential of your animals — as soon as they're born. Genomic testing increases your herd's profitability through:

Increased Genetic Gain: Genomic profiles provide the accuracy of progeny tests based on 20 milking daughters, while traditional parent averages equate to seven daughters. Expected gains in net merit add tremendous value to dairy herds.

Parentage Verification: Parentage errors are found in approximately 15% of animals tested.

Management of Inbreeding: Avoid negative effects of inbreeding by managing your inbreeding coefficient – even without pedigree knowledge.

Confident Mating Decisions: With production, health and fertility traits identified early on, you can match your heifers' genomic profiles with the right bulls to improve your herd.

A Igenity-Essential: \$32

The Igenity-Essential test is a streamlined offering for commercial dairy farmers that need, well, the essentials. As the most economical test on the market, Igenity-Essential brings the power of genomic technology to your dairy without the bottom line impact. Fifteen of the most economically impactful traits, with data delivered to you faster than any other test on the market. It provides a cost-effective simple sorting tool for commercial heifers that does not rely on submission to the CDCB. Igenity-Essential is available for Holstein and Jersey purebred cattle.

Turnaround Time	Reliability	Parentage
17 Days	~60-65%	Sire confirmation

Traits			
Net Merit Milk Yield Fat (lbs) Fat (%) Protein (lbs) Protein (%)	Cheese Merit Fluid Merit Somatic Cell Score Productive Life	Daughter Pregnancy Rate Daughter Calving Ease* Daughter Stillbirth*	PTA Type* Dairy Form*

**Only available for Holstein animals*

Genomics



Igenity-Select: \$40

An excellent decision-making tool for the commercial dairy, Igenity-Select is a streamlined genomic profile that provides highly reliable results at a significant value for cost-conscious producers. It is powered by a low-density chip with custom content, and supported by the CDCB to give accurate results. This test is available for purebred Holstein, Jersey, and Brown Swiss cattle.

Turnaround Time	Reliability	Parentage
17 Days	67-71%	Sire discovery

Traits			
Net merit	Genomic future inbreeding	Stature Strength	Front teat placement
Milk yield	Fat (%)	Body depth*	Rear teat placement*
Fat (lbs.)	Protein (%)	Dairy form	Teat length
Protein (lbs.)	Cheese merit	Rump angle	Coat color (including black/red)*
Somatic cell score	Fluid merit	Thurl width	Dominant red coat color*
Productive life (months)	Sire calving ease*	Rear legs side view	Haplotype polled
Daughter pregnancy rate*	Heifer conception rate	Rear legs rear view*	Haplotype brachyspina*
Daughter calving ease	Cow conception rate	Foot angle	Haplotype CVM*
Igenity performance index (IPI)	Daughter stillbirth*	Feet and leg score*	HCD*
Grazing merit	Sire stillbirth*	Fore udder attachment	BLAD*
Final score (PTAT)	Haplotype status	Rear udder height	DUMPS*
	Feet/legs composite*	Udder cleft	Mulefoot*
	Udder composite*	Udder depth	

*Traits not available for all breeds

Did you know?

Every 1% increase in inbreeding equals \$22-24 less profit per cow[†].

[†]Smith LA, Cassell BG, Pearson RE. Effects of Inbreeding on Lifetime Performance of Dairy Cows. *Advances in Dairy Technology*. Volume 11. (1999) 13.

Testimonial

First of all, the help and service I get from the Neogen staff is second to none. I receive the information I need via text message on a weekly basis, and someone is always there to provide me with any additional genomics information that I may need. With this technology, and the service and expertise behind it, I've been able to expedite the genetic improvement of my herd through properly managed breeding. The price is very competitive, and with the increased efficiency of my operation, I'm able to realize a complete return on my investment within a year.

- Derek Vander Eyk
Robert Vander Eyk & Sons Dairy
Pixley, CA





Igenity Dashboard: **FREE** for Igenity Customers

It's important to make sure that anyone using genomics has a genomic protocol in place. A genomic protocol is simply a plan for how an individual dairy producer plans to use the information. Based on which criteria does the producer plan to sort and rank heifers? There are many indexes, such as NM\$ (Net Merit Dollars), that are a great place to start.

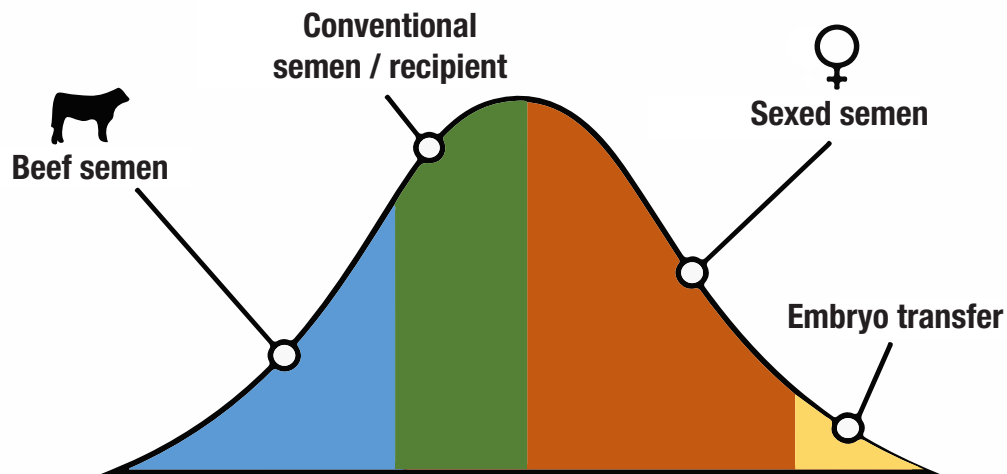

Once a method of ranking heifers is implemented, a plan needs to be created to determine how to use this information. Will embryo transfer be used on the top females? Will any sexed semen or beef semen be used... and on what percentage of the animals? It's important to think about these factors and the economics associated with each of these decisions in order to determine the right solution for the dairy. With genomics, there isn't one "right" way to use the information. There are many ways that can make sense and provide a great return on investment for the commercial dairy.

The Igenity Dashboard is an application that allows for simple viewing and interpretation of genomic testing results. Every Igenity producer receives complimentary access to the program, with the ability to share log-in privileges with stakeholders on your dairy. With Dashboard, you will:

- View various reports about your animals
- Customize reports to show only the traits you need
- Create custom indices to meet your specific breeding goals
- Compare your herd to all herds in the breed database
- See progress in your herd over time

***Interested in the program?
Call 877-IGENITY for a demonstration log-in.***



Genomics

Igenity Dashboard - Genetic information in the palm of your hand

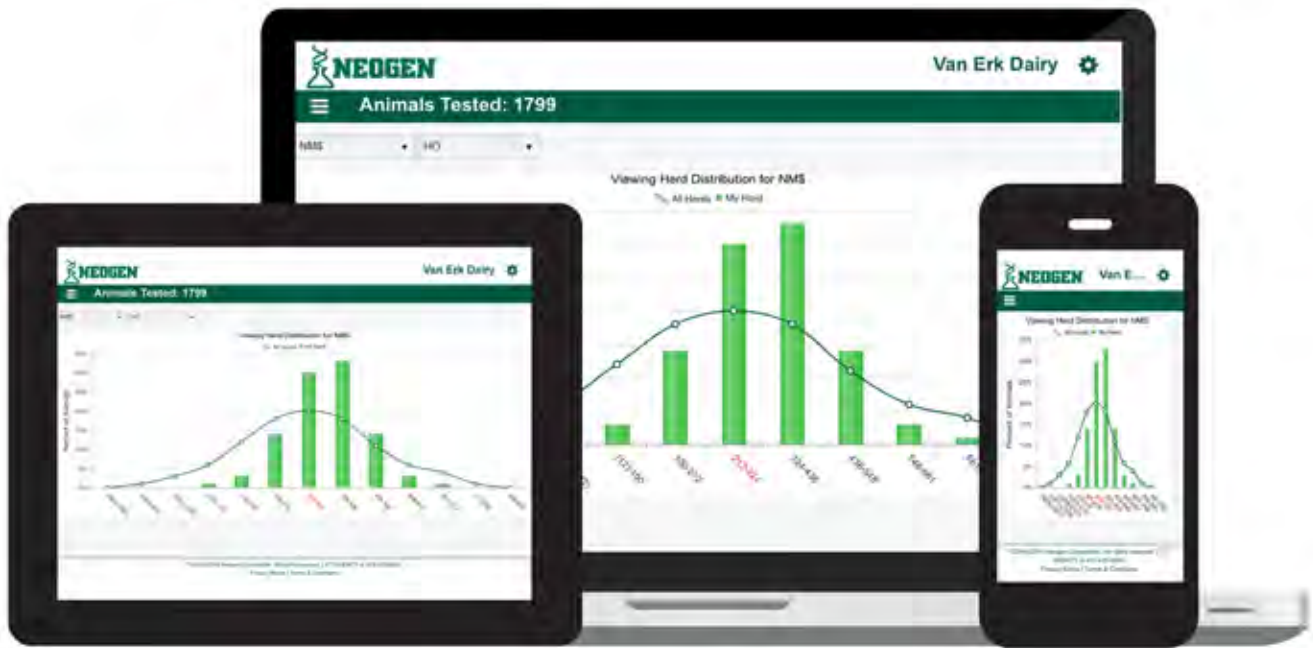

Getting started is easy!

1

Determine your needs.

The Igenity Dairy Heifer Program offers a variety of testing options to best suit your needs. Contact your Neogen representative for a free consultation on how to make the program work for you.

2

Collect samples.

Samples can be submitted via tissue samples, hair follicle samples and blood cards. Sample collection devices are available for purchase at genomics.neogen.com. Follow Neogen's shipping instructions and deadlines for the fastest turnaround times.

3

Analyze your results.

Your results can be returned in an Excel® report, pdf, directly input into your herd management software or via your Igenity Dashboard account. Your Neogen representative can help analyze your results to reach your herd's full genetic potential.

Breeding Diagnostics

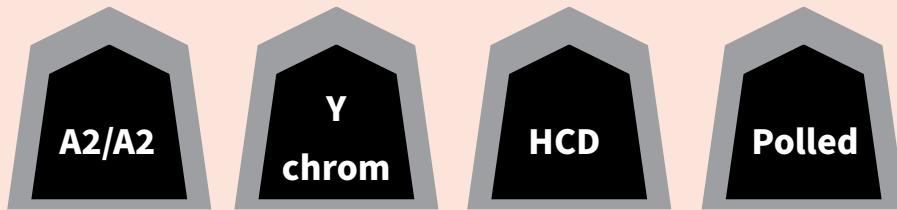

Are you feeding genetic liabilities or assets?



A

BioPRYN® Early Pregnancy Detection

GeneSeek is a certified BioTracking laboratory offering the BioPRYN early stage bovine detection pregnancy diagnostic assay service for beef and dairy cattle producers. BioPRYN is a safe and accurate blood test that provides an easy alternative to palpation and ultrasound in cattle. BioPRYN measures the presence of pregnancy-specific protein B (PSPB) in the animal, a protein only produced by the placenta of a growing fetus. Cows and heifers must be 28 days post-breeding and cows 73 days post-calving to for accurate results.

B

Horned/Polled Testing

The confirmatory test for polled determines if the animal has one or two copies of the dominant polled gene, giving you the information to move your herd away from dehorning practices.

C

Holstein Cholesterol Deficiency (HCD)

A confirmatory test for Holstein Cholesterol Deficiency (HCD) which causes decreased cholesterol production in Holstein cattle. The genetic mutation leaves an animal without the ability to convert energy to fat, seriously impacting basic biological function and causing eventual fatality.

D

A2 Beta-casein

Testing for A2 may allow you to better market your animals. A2 is the beta-casein protein variant that was initially found in cattle. Through selection for high milk production, a mutation occurred creating A1 and A3 variants of the protein. Today, most Holstein animals have the A1 variant. Studies have suggested that there are potential human health benefits associated with consuming A2 milk, and producers in a number of countries are selling their A2-verified milk at a premium.¹

¹ Bell SJ, Grochoski GT, Clarke AJ. Health Implications of Milk Containing B-Casein with the A2 Genetic Variant



Semen Collection



ElectroJac® 6

The Complete ElectroJac 6 System, with your choice of 1", 2", 2.5" or 3" probe. Ideal's ElectroJac 6 combines the best of more than 30 years experience in automated semen collection instrument design and manufacturing, with state-of-the-art technology, featuring its unique flexibility of automatic and manual settings, ElectroJac 6 is the perfect field unit for even hard-to-collect bulls.

- Unparalleled simplicity of use
- Improved electronics to prevent overcharging
- Powerful gel cell battery
- Bright numeric display
- Trade-in program available



6906-1*

C101



C100



6989

6990

6992

6993

* Additional sizes available

The Best Just Got Even Better...

ElectroJac 6



COOKIECUTTER MOM **HUNTER-ET** 097HO40346

Item No.	Description
6906-1	ElectroJac 6 Complete w/1" probe
6906-2	ElectroJac 6 Complete w/2" probe
6906-25	ElectroJac 6 Complete w/2.5" probe
6906-3	ElectroJac 6 Complete w/3" probe

The complete kit includes:

6901	ElectroJac 6 Carrying Case
6903	ElectroJac 6 Battery Charger AC
6910	ElectroJac 6 Dwell Cable Assembly 20'
6912	ElectroJac 6 Probe Cable Assembly 20'
6915	ElectroJac 6 Wireless Dwell Remote
6916	ElectroJac 6 European/Universal Battery Charger
6983	Semen Collection Director Cone
C100	Semen Collection Cone 100/pk
6984	Semen Collection Vials
6985	Semen Collection Handle Assembly
6986	Scrotal Tape Metric
6989	ElectroJac 6 Ram/Boar Probe 1" (25mm)
6990	ElectroJac 6 Bull Probe 2" (51mm)
6992	ElectroJac 6 Bull Probe 2.5" (64mm)
6993	ElectroJac 6 Bull Probe 3" (77mm)

ElectroJac 6 Accessories

6902	ElectroJac Replacement Battery
C101	Semen Collection Vials 100/bag

**NOW
CONTROLLED BY
WIRELESS
REMOTE**



Breeding Supplies

A

PolyLube®

Concentrated Powder Lubricant

PolyLube is a non-sterile, concentrated powder lubricant for obstetrical activities on horses and cattle.

Item No.	Description	Case Ct.
PL114	PolyLube 10oz	12



B

General Lube

Non-Sterile Lubricating Jelly

General Lube is a non-sterile, non-spermicidal viscous lubricant for use during obstetric and rectal exams.

Item No.	Description	Case Ct.
79212	General Lube 8oz	12



C

Chemise

Protective sleeves to pull over insemination rods that help prevent transmission of contaminants during insemination or embryo transfer. Comes in perforated, easy-tear rolls.

Item No.	Description	Case Ct.
TA837C-18	Chemise Sanitary 18" For AI Pack 100/bx	12
TA837C-21	Chemise Sanitary 21" For ET Pack 80/bx	12



D

Tweezers

Specially designed polyester tweezers for easy removal of semen straws from canisters. The grooved tip grips and surrounds the straw without crushing. Transmits little heat or cold. Individually wrapped. 6.5" (16.51cm) long.

Item No.	Description
Tweezers	Cito Straw Tweezers 6.5"

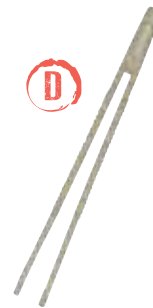

E

Cutters

Designed to quickly cut off the sealed end of semen straws. It is made of non-corrosive plastic with a stainless steel blade which cuts off the proper length with a push of the button. Easy to disassemble and wash without tools. 2.25" (5.72cm) diameter.

Item No.	Description
Cutters	Cito Straw Cutters



F

Universal Syringe

This stainless steel syringe gun will seat both ½cc (0.5mL) and ¼cc (0.25mL) semen straws, just by changing the direction of the barrel, O-ring style uses slit sheaths with green insert. 17.5" long.

Item No.	Description
D301	Universal Syringe



G Infusion Tubes

Drilled infusion tubes have one uniquely drilled end which allows for a tight fit with any standard luer-tip syringe, eliminating the need for connector adapters. Made from high quality polymers with round, smooth and polished ends for easier insertion. 25 tubes/bag, 40 bags/case.

Item No.	Description	Case Ct.
AI2100	Infusion Tubes Drilled 21" 25/bag	40



H Sheaths Slit

PVC sheaths designed with an insert that provides a secure seat for a semen straw. Slit to work with O-ring guns. 17.5" long, 0.178" outer diameter.

Item No.	Description	Case Ct.
4405C SYR	Sheaths w/Green Insert/Slit 50/pk	20

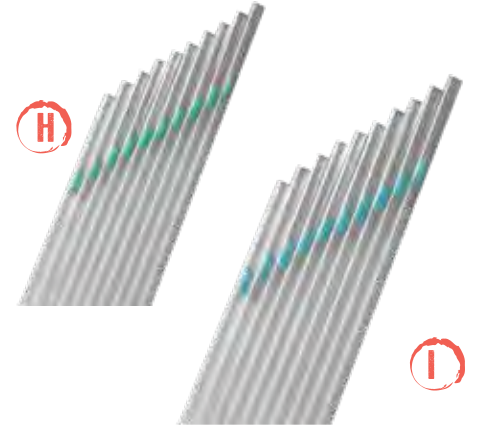

I Sheaths Unslit

PVC sheaths designed with an insert that provides a secure seat for a semen straw. Unslit to work with spiral guns. 17.5" long, 0.178" outer diameter.

Item No.	Description	Case Ct.
4505C SYR	Sheaths w/Blue Insert/Unslit 50/pk	20

J Kamar Heat Detector

The Kamar detector is a pressure sensitive device that glues on the tail head of the cow. Requires 3 seconds of pressure to activate detector from white to red. Each box contains 25 detectors, a tube of glue, instructions and plastic applicator.

Code	Category	Description	Count	Case
4999-1180-036	Adhesive	Adhesive Kamar Heat Detector	1	25
4999-1180-034	Detector	Kamar Heat Detectors	25	40



Calving Supplies



Dr. Frank's® Calf Puller

Dr. Frank's Calf Puller is the original obstetrical instrument developed by B.N. Frank, DVM, a specialist in veterinary obstetrics. Dr. Frank's is a precision instrument that has proven its effectiveness year after year in thousands of calving cases.

The uniform tension of this unique fetal extractor does not permit slipping or backing-up of the jack. Traction on the calf and the counter-thrust against the cow induce spreading of the pelvic bones, elevation of the abdomen, and arching of the animal's back, all assisting in the natural birthing process.

The entire unit can easily be assembled in minutes. The smooth rods unscrew for easy storage and cleaning. Dr. Frank's comes packaged with a 45" OB chain. Made in the USA.



Item No.	Description
3003	Dr. Frank's Calf Puller
3005	Jack for Dr. Frank's
3006	72" Rods (pair)
3008	Breechen 23"
3009	Web Strap
3010	Vinyl Carrying Case Dr. Frank's Calf Puller
3011	Jack Handle for Dr. Frank's Calf Puller
9784	Dr. Frank's Cams & Springs Kit

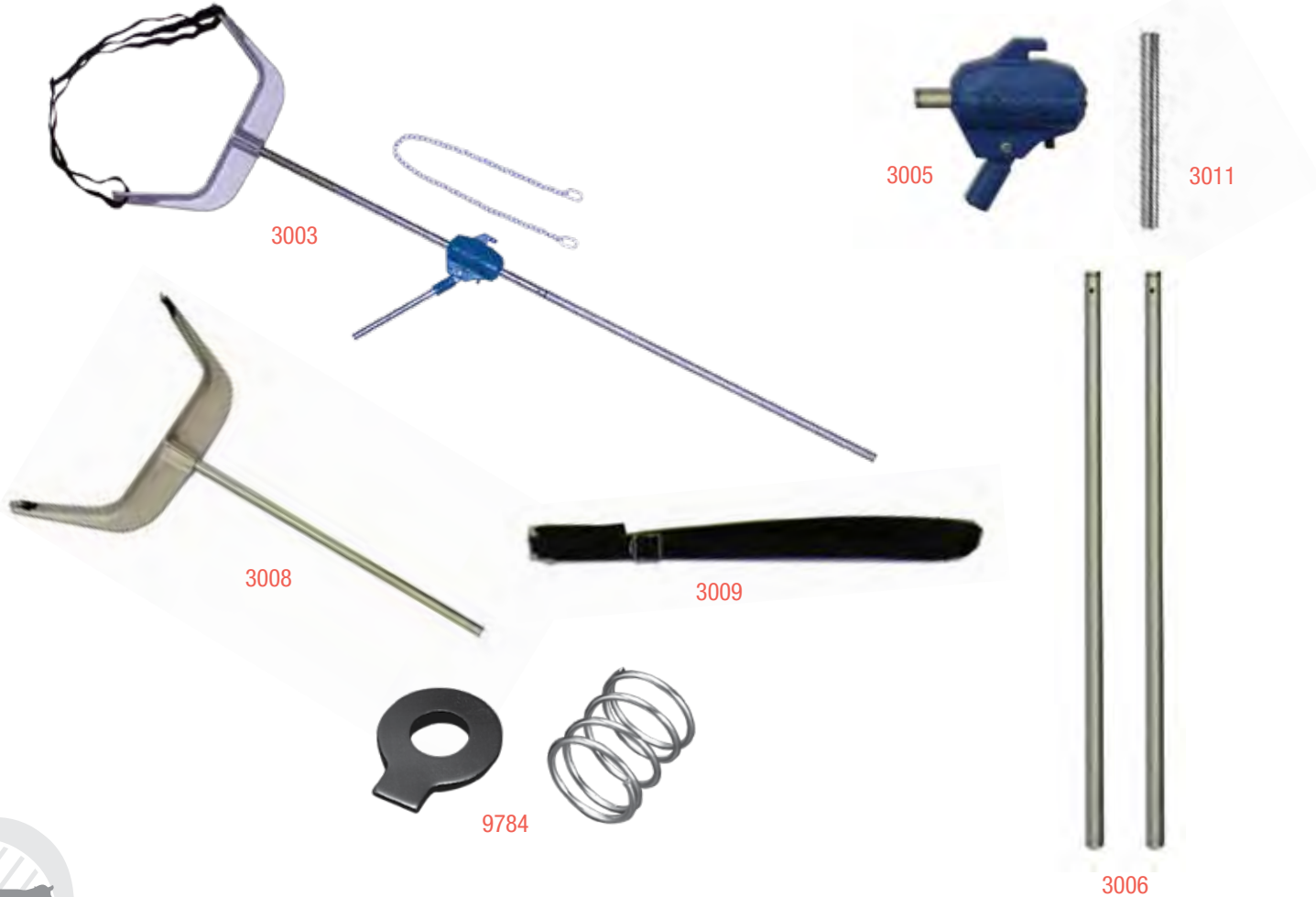



Calf-Eze™ Calf Puller

Calf-Eze is engineered for the user that prefers a dual action pull, or zig-zag motion, instead of a single action pull instrument.

Calf-Eze is superior to ratchet-style pullers that rely on grooved shafts with sharp edges and hard-to-clean grooves. Calf-Eze utilizes the same non-slip cam traction system as the Dr. Frank's Calf Puller, but has two pulling points that alternatively advance to shift the pull from one leg to the other.

The dual-action jack body is made of special strength aluminum and weighs only 17lbs. The jack assembly mechanism allows the user to easily position the jack on the rods and lock it in place. Steel cams prevent slipping and provide longer jack life. A third chain hook is also provided to give a single-pull option.

The Calf-Eze is suggested for use with two 45" OB chains (not included); available as item 3102 - see page 16). Made in the USA.

Item No.	Description
3022	Calf Eze Calf Puller, complete unit
3024	Calf Puller Jack for Calf-Eze
3006	72" Rods (pair)
3008	Breechen 23"
3009	Web Strap
9785	Calf-Eze Cams & Springs Kit



Ratchet-Style Calf Puller

The Ratchet-Style Calf Puller can be your solution to difficult deliveries. Crafted with the finest quality steel, it will stand up to the toughest deliveries without letting you down.

The Ratchet-Style Calf Puller features steel rods that easily disassemble for cleaning and storage. The rods have smooth, clean grooves that lessen wear on the jack and give a much quieter ratchet than competitors' pullers. The jack is extremely durable, and has a large, comfortable handle that allows for single person operation. Large handles also greatly reduce the incidence of breakage, or pinched fingers and hands.

The rods screw into the breechen, which provides stability during the birthing process. The Ratchet-Style Calf Puller comes with a standard 66" rod and has an additional attachment to extend the rod to a full 78".

The jack conveniently offers both a zig-zag pull and a single-pull option. Many prefer the zig-zag pull as it helps avoid locking of the calf's shoulders in the pelvic opening.

Item No.	Description
3020	Calf Puller Ratchet Style

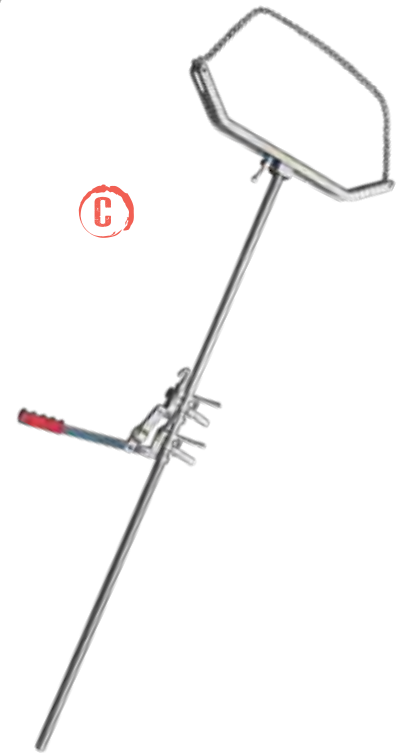

Did you know?

Studies consistently show that bull calves require more calving assistance than heifer calves†.



†USDA: Animal and Plant Health Inspection Service: Veterinary Services, Centers for Epidemiology and Animal Health

Calving Supplies (cont.)

D OB Chain and Handles

NEOGEN's high quality OB accessories are a comfortable fit for any delivery. The OB handle is 1/2" in diameter and has a poly coated grip. The larger diameter and comfort grip make those difficult births easier on your hands. The durable, high strength OB chains come in 30", 45" and 60" lengths. Both the chains and handles are zinc-plated with an added rust inhibitor.

Item No.	Description
3104	OB Handle w/Poly Grip WARNING: This product can expose you to chemicals including Di(2-ethylhexyl) Phthalate ("DEHP"), which is known to the State of California to cause cancer and birth defects or other reproductive harm. For more information go to www.P65Warnings.ca.gov .
3100	OB Chain 30"
3101	OB Chain 60"
3102	OB Chain 45"



E OB Strap

Heavy-duty 1" nylon makes our straps weather and mildew resistant. Nickel-plated, welded steel D-rings on both ends. Economical alternative to OB chains. For use with OB Handles.

Item No.	Description
3111	OB Strap Nylon 1"x30"
3112	OB Strap Nylon 1"x60"



F Calf Snare

Neogen's Save-a-Calf Snare loop is easily made larger or smaller by simply sliding the yoke. The snare is fabricated from high grade steel cable and has a thimble for use with Neogen's OB handle.

Item No.	Description
3108	Calf Snare Save-A-Calf Steel Cable



G Wire Saw

The 27-strand stainless steel wire saw provides easy and quick cutting. Packaged in a reusable plastic dispenser to prevent tangling. Handles come as a pair and are nickel-plated for easy clean-up. Thumb screws lock the wire in place.

Item No.	Description
3115	OB Wire Saw Stainless Steel 32"
3116	OB Wire Saw Handles 1 pr



H Pro-Fix® Button

Designed for internal fixation of vaginal prolapse in a pre-parturient cow, the Pro-Fix button will reduce the prolapse, keep it from recurring and allow for normal parturition without assistance.

Item No.	Description
J100	Pro-Fix Button VPR 1 kt





Pro-Fix® Tubes

Designed for the repair of rectal prolapse in swine, ovine, and bovine, Pro-Fix Tubes eliminate the stricture problems sometimes associated with reduction methods of treatment. These precision molded, disposable plastic tubes are made in 5/8", 3/4", 1", 1 1/4", 1 1/2" and 2" OD sizes. The tubes are fully tapered on one end for easier insertion and have extra deep center grooves for better retention. The 1 1/2" and 2" OD sizes have holes in the center groove for suturing in place. Pro-Fix Tubes are available in various sizes.

Item No.	Description
R050	Pro-Fix Tubes 5/8" 24ct
R075	Pro-Fix Tubes 3/4" 16ct
R100	Pro-Fix Tubes 1" 12ct
R125	Pro-Fix Tubes 1.25" 16ct
R150	Pro-Fix Tubes 1.5" 16ct
R200	Pro-Fix Tubes 2" 9ct



Vet-Tie™

Vet-Tie Braided Tape is a non-sterile, polyester braided tape developed for use with Pro-Fix Tubes (rectal rings) in repairing rectal prolapse in swine, ovine, and bovine. Available in narrow and wide widths, Vet-Tie can also be used in surgical procedures as a suture material or umbilical tape. Vet-Tie Braided Tape is packaged in a unique plastic vial, which permits dispensing of tape without removing the lid.

Item No.	Description
V125	Vet-Tie Narrow 1/8" 30yds
V375	Vet-Tie Wide 5/16" 30yds



Apparel

A Genia Extra-Protection

Genia OB sleeves provide extra protection by covering the shoulder, chest and underarm area. The sleeve is held firmly in place by a neck strap. Sleeve measures 48" from fingertip to neck strap.

Item No.	Description	Case Ct.
307620	Genia Extra-Protection OB Sleeve w/Neck Strap 50/bx	10



B BreederSleeve®

Affordable, quality shoulder length sleeves, packaged in a convenient dispenser box. Red, 1.0 mil, 36" length.

Item No.	Description	Case Ct.
BS100	BreederSleeve 100/bx	10



C BreederSleeve® Plus

Economical extra-long sleeves, packaged in a convenient dispenser box. Orange, 1.0 mil, 39" Length

Item No.	Description	Case Ct.
BSP100	BreederSleeve Plus 100/bx	10



Neogen is the standard of quality when it comes to breeding sleeves. We offer multiple combinations of lengths, thicknesses, and styles, including sterile options, whether used in artificial insemination, pregnancy checking or surgery. With Neogen's numerous choices of OB sleeves to choose from, we provide the perfect fit for everyone.

D MaxiSleeve®

Disposable MaxiSleeve OB sleeves are made from a blended polymer film for an optimum strength to sensitivity ratio. Packaged in resealable, pressure-sealed bags (PolyPack). 39" length.

Item No.	Description	Case Ct.
M100	MaxiSleeve 1.1 mil Yellow 100/pk	10
M125	MaxiSleeve 1.25 mil Brown 100/pk	10
M125-F	MaxiSleeve 1.25 mil Brown Fingerless 100/pk	10
SM100	MaxiSleeve 1.1 mil Yellow Sterile 12/pk	12
SM125	MaxiSleeve 1.25 mil Brown Sterile 12/pk	12
SM125-F	MaxiSleeve 1.25 mil Brown Sterile Fingerless 12/pk	12





PolySleeve®

Disposable, polyethylene PolySleeve OB Sleeves are packaged in resealable, pressure-sealed bags (PolyPack).

Item No.	Description	Case Ct.
P100	PolySleeve 1.1 mil Buff 100/pk	12
P125	PolySleeve 1.25 mil Blue 100/pk	10
P125-S	PolySleeve 1.25 mil Blue Small Hand 100/pk	10
SP100	PolySleeve 1.1 mil Sterile 12/pk	12
SP125	PolySleeve 1.25 mil Sterile 12/pk	12
SP125-S	PolySleeve 1.25 mil Sterile Small Hand 12/pk	12



PolyPetite™ Sleeve

The PolyPetite is the best fitting small-hand sleeve on the market! Slimmer fitting through the fingers, wrist and arm for easier palpations by small-handed technicians. Packaged in a convenient dispenser box. Also available sterilized. Available in 1.25 mil, 36" length. *NEOGEN is proud to announce that 10% of sale proceeds of our PolyPetite sleeves will be donated to the Markey Cancer Foundation for breast cancer research.*

Item No.	Description	Case Ct.
P125-P	PolyPetite Pink 100/bx	10



Standard OB Sleeves

Designed for OB and AI use, Ideal's shoulder-length sleeve is a premium sleeve at an economy price. Made from a high quality polyethylene fiber for maximum strength and optimal sensitivity. 1.25 mil, 39" length.

Item No.	Description	Case Ct.
3106	Standard OB Sleeves 36" Clear 100/bx	20
3110	Standard OB Sleeves 36" Clear 10/pk	80
TA843	Standard OB Sleeves 36" Orange 100/bx	10



PolySem® Polytactyl®

The ultimate in strength and touch sensitivity. Packaged in a convenient dispenser box. 36" overall length, yellow, 1.3 mil.

Item No.	Description	Case Ct.
VGT3090	Polytactyl 1.3 mil 100/bx	10



PolySem® Special Deliverance® Sleeves

Disposable Special Deliverance sleeves provide excellent strength and are ideally suited for most animal health applications. Packaged in a convenient dispenser box. 36" overall length, orange, 1.2 mil

Item No.	Description	Case Ct.
VGS3090	PolySem Special Deliverance Sleeves 100/bx	10



Apparel (cont.)

K

OB Gown

Full length navy blue veterinary OB Gown with short sleeves for maximum coverage and protection when performing cesarean sections and other large animal procedures. Made from urethane coated nylon oxford material that is highly water resistant, breathable and machine washable. Has Velcro fasteners in the back for a secure fit. Available in Large & XLarge.

Item No.	Description
----------	-------------

VA500-L	OB Gown L
VA500-XL	OB Gown XL

K



L

OB Jacket

Short sleeve OB jacket with button front closure that covers down to the mid-thigh that is breathable for comfort. Navy blue colored urethane coated nylon that is highly water resistant and machine washable. Available in Large & XLarge.

Item No.	Description
----------	-------------

VA301-L	OB Jacket L
VA301-XL	OB Jacket XL

L



M

OB Suit

Get full protection for large animal procedures with this highly water resistant and breathable urethane coated nylon oxford OB Suit. Short sleeve pull over top and pants bottoms sold separately. Navy blue color and machine washable. Available in Medium, Large & XLarge.

Item No.	Description
----------	-------------

VA101-M	OB Suit Top M
VA101-L	OB Suit Top L
VA101-XL	OB Suit Top XL
VA102-M	OB Suit Bottom M
VA102-L	OB Suit Bottom L
VA102-XL	OB Suit Bottom XL

M



N

Shoulder Protector

Urethane coated nylon oxford material that is highly water resistant for protection from fluids and manure during OB and AI procedures. Has an elastic sleeve support to keep OB sleeves in place. May be worn on either arm and has adjustable straps for a secure fit. Navy blue in color and machine washable.

Item No.	Description
----------	-------------

VA900-L	OB Shoulder Protector L
---------	-------------------------

N



O

Vet Apron

Large full length Vet Apron with extra-long ties in one-size fits all. Made from a urethane coated nylon oxford material that is highly water resistant and breathable for maximum comfort. Navy blue color and Machine washable. One size fits all.

Item No.	Description
----------	-------------

VA400	Vet Apron 1 Size
-------	------------------

O



Originally designed for veterinarian use when performing large animal procedures, Ideal's veterinary apparel is made from a urethane coated nylon oxford material. The garments are navy blue in color, highly water resistant, breathable and machine washable. Custom sizes of all garments may be special ordered.

P **Vet Overall**

Designed for veterinary use providing complete protection these Vet Overalls are made from urethane coated nylon oxford material that is highly water resistant and breathable. Straps have Velcro fasteners for a secure fit. Navy Blue color and machine washable. Available in Large & XLarge

Item No.	Description
VA600-L	Vet Overall L
VA600-XL	Vet Overall XL



Q **PolyGown**

Made of 1.3 mil lightweight embossed polyethylene film, the Ideal PolyGown is designed for veterinary and livestock applications where minimal protection is needed. PolyGown is packaged in a convenient dispenser box for easy removal and is available in three sizes.

Item No.	Description
DG100-M	PolyGown M 20/bx
DG100-L	PolyGown L 15/bx



Dairy Hygiene

**Cleaners & Disinfectants • CIP (Clean-in-Place) & Bulk Tank Cleaners
Acid Detergents • Teat Dips & Udder Washes**

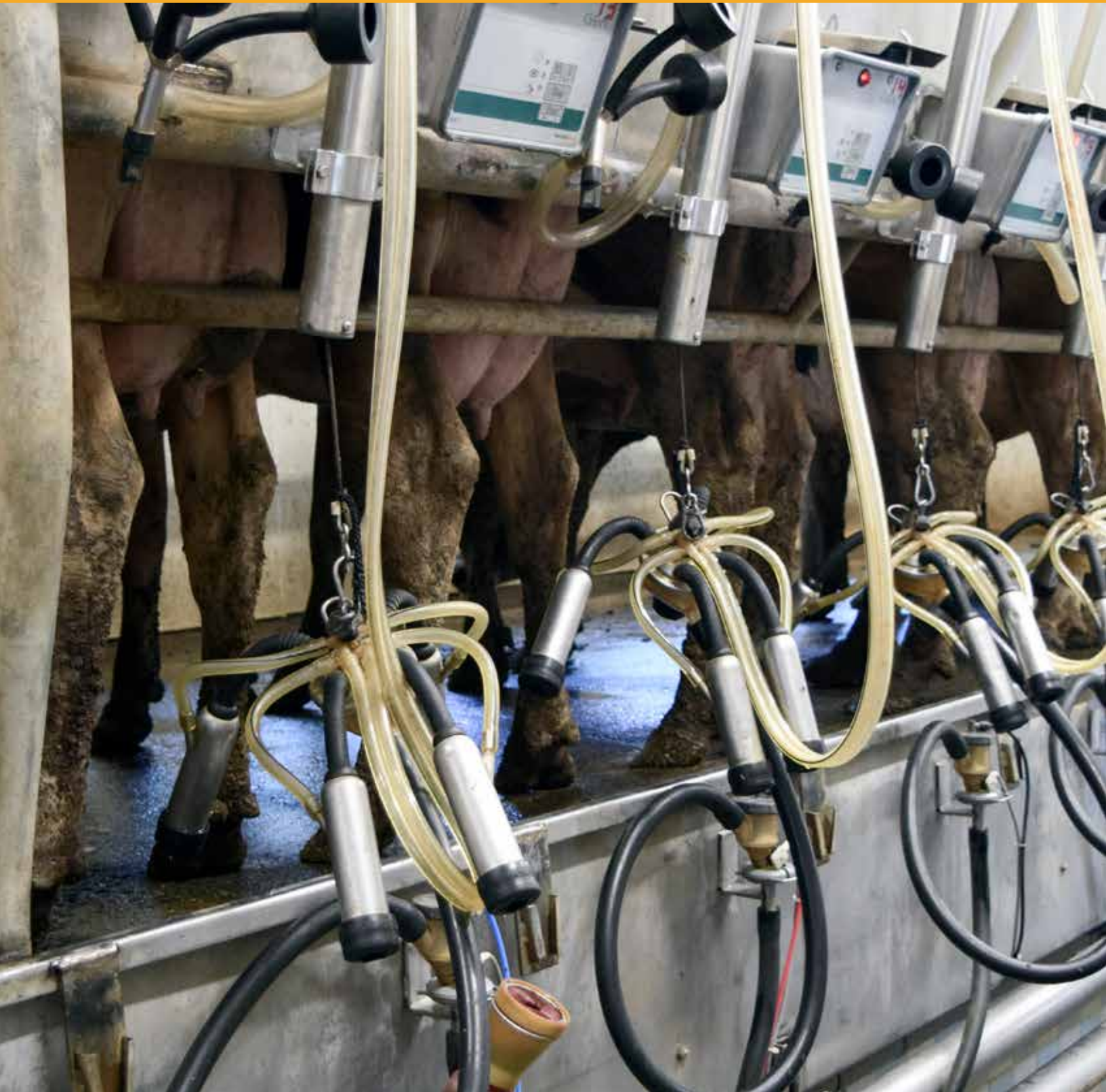

Dairy Hygiene

Cleaners & Disinfectants

Neogen's line of Dairy Hygiene products for Clean in Place and Bulk Tanks includes both alkaline and acid detergents as well as specialty products for residue and build-up. These products are manufactured in California and Tennessee to maximize freight efficiencies. Tetradyne dairy chemicals are formulated to keep your milking equipment clean and residue free. We offer a variety of strengths that can be used in combinations of daily use and shock treatments as needed. During seasonal changes, our technicians can recommend products to use before you see a problem. Using the alkaline, acidic and sanitizing products in combination, as recommended, will help keep your equipment bacteria counts low and your milk quality high.

Manual Cleaners



Ascend

An economical liquid, high foaming all-purpose cleaner and hand wash.

Item No.	Available Sizes
603122	1 gal, 30 gal, 55 gal



Ascend II

A premium liquid, high foaming general purpose cleaner and hand wash.

Item No.	Available Sizes
680036	1 gal, 15 gal, 55 gal



Tetrabase L8

Chlorinated high foaming cleaner.

Item No.	Available Sizes
602242	5 gal



Tetraspec LX

A high foaming, chlorinated, general purpose, alkaline powder detergent for use as a manual cleaner.

Item No.	Available Sizes
603001	40 lb, 100 lb, 400 lb



Tetracid-700

Foaming Acid cleaner and brightener. Recommended for foaming applications on equipment, floors and walls. Let stand and rinse with high pressure wash.

Item No.	Available Sizes
602056	1 gal, 5 gal

Cleaners & Disinfectants (cont.)

Laundry

F

Tidmore

Concentrated liquid laundry detergent for washing soiled rags in dairy farms.

Item No.	Available Sizes
----------	-----------------

602120	5 gal
--------	-------

G

Tidmore CL

Chlorinated version of Tidmore.

Item No.	Available Sizes
----------	-----------------

602291	15 gal, 55 gal, 275 gal
--------	-------------------------

H

Tidet CL

Concentrated with chlorine powder laundry detergent used for the washing of soiled rags in dairy farms.

Item No.	Available Sizes
----------	-----------------

602289	100 lb, 400 lb
--------	----------------

I

Resolve

A liquid organic acid based detergent for the removal of polymeric adhesive residues in pipelines.

Item No.	Available Sizes
----------	-----------------

652104	5 gal
--------	-------

J

Catalize

A liquid additive containing water softening and chelating agents used primarily for injection into CIP systems to boost cleaner performance on dairies with high water hardness and/or butterfat content.

Item No.	Available Sizes
----------	-----------------

602206	275 gal
--------	---------

Sanitizers & Disinfectants

A

Coresan 12.5

A 12.5% liquid sodium hypochlorite sanitizer.

Item No.	Available Sizes
----------	-----------------

650410	5 gal, 15 gal, 55 gal
--------	-----------------------

B

Iodis

An iodine based liquid sanitizer-disinfectant containing 1.75% titratable iodine and phosphoric acid.

Item No.	Available Sizes
----------	-----------------

433300	1 gal, 30 gal, 55 gal
--------	-----------------------



Mycocide

An effective low foaming detergent sanitizer containing 3.5% iodine and phosphoric acid.

Item No.	Available Sizes
413090	1 gal, 15 gal, 55 gal

CIP (Clean-in-Place) & Bulk Tank Cleaners

Proper and thorough pipeline and bulk tank cleaning is essential milk safety and quality. Neogen’s selection of high quality cleaners and detergents are designed to perform in any system with exceptional results and are available with chlorinated, non-chlorinated and powdered products.



Cycle One

Two in one detergent to help lower energy and water use and time for wash down.

Low foaming liquid acid cleaner for use as a single cycle spray and CIP cleaning.

Rinse the system with clean water, then drain. Use Cycle One and circulate for 8 to 10 minutes starting at 150° to 160° F and maintain the temperature above 100° F throughout the cleaning cycle, Drain. Sanitize surfaces immediately prior to next milking.

Item No.	Available Sizes
601045	1 gal, 5 gal, 15 gal, 30 gal, 55 gal, 250 and 275 gal totes

Liquid Chlorinated Cleaners

A series of pipeline and bulk tank cleaners containing sodium hydroxide, polymers, water conditioners and chlorinating agent.



Tetrabase-75

A heavy duty liquid alkaline pipeline cleaner containing sodium hydroxide, anti-redeposition polymers, water softening agents, stabilizing and chlorinating agents.

Item No.	Available Sizes
652202	30 gal, 55 gal, 250 gal tote



Tetrabase-100

A liquid alkaline pipeline and bulk tank cleaner containing sodium hydroxide, anti-redeposition polymers, water softening agents, stabilizing agents and a chlorinating agent. Tetrabase-100 cleans and disinfects efficiently while being gentle on milking equipment and liners and works well in hard-water.

Item No.	Available Sizes
652052	15 gal, 30 gal, 55 gal, 250 gal tote



Tetrabase-150

Formulated with potassium hydroxide (for better rinsability), water softening agents, anti-redeposition polymers, dispersants and a chlorinated compound. Effective protein and butter fat removal properties at economical dilution rates.

Item No.	Available Sizes
602038	5 gal, 30 gal



CIP (Clean-in-Place) & Bulk Tank Cleaners



Tetrabase-350

Phosphate Free – Heavy duty liquid alkaline pipeline and bulk tank cleaner containing sodium hydroxide, anti-redeposition polymers, water softening agents, stabilizing and chlorinating agents. Recommended for applications where heavy butterfat and oily solids are encountered.

Item No.	Available Sizes
602040	15 gal, 55 gal, 275 gal tote

Non-Chlorinated CIP Cleaners

A series of concentrated, heavy duty pipeline and bulk tank cleaners built with sodium hydroxide, water conditioners and inhibitors.



Tetrabase-400

Concentrated heavy duty pipeline and bulk tank cleaner developed to provide maximum hydroxide alkalinity along with dispensing agents, water softeners, wetting agents and iron inhibiting ingredients. Economical alternative.

Item No.	Available Sizes
602098	55 gal, 250 gal tote



Tetrabase-70

Developed to provide maximum hydroxide alkalinity along with dispensing agents, water softeners, wetting agents and iron inhibiting ingredients. Economical alternative due to the high dilution rates. Designed for the removal of heavy soils with a high level of water conditioning ability and alkalinity that is easily rinsed after cleaning.

Item No.	Available Sizes
616145	5 gal, 15 gal

Powder CIP Cleaners

A series of pipeline and bulk tank cleaners formulated with sodium hydroxide, water softeners, dispersants and chlorinating agent. Tetrabase-P3 & P4 are the “everyday” workhorse for most CIP cleaning applications.



Tetrabase-P3

Blend of alkaline hydroxide builders, water softening agents, dispersants and chlorinated compound. Chlorinated alkaline heavy duty tank cleaner. Excellent butterfat saponification and milk protein soil detergency.

Item No.	Available Sizes
652069	40lb, 100lb, 400lb

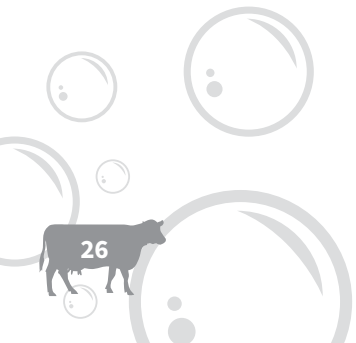

Acid Detergents

A

Resolve

Resolve is a liquid organic acid that removes polymeric adhesive residues from pipelines and bulk tanks. If teat sealant is allowed to build up in the system, bacteria can become a problem.

Item No.	Available Sizes
----------	-----------------

652104	5 gal
--------	-------

B

Tetracid

An economical acid blend used as a CIP acid detergent for dairy farm pipeline and bulk tank applications.

Item No.	Available Sizes
----------	-----------------

618087	1 gal, 15 gal, 30 gal, 55 gal, 250 and 275 gal totes
--------	--

Tetracid-500

A versatile blend of phosphoric, nitric, and sulfuric acids used for pipeline and bulk tank cleaning applications.

C

Item No.	Available Sizes
----------	-----------------

652072	15 gal, 30 gal, 55 gal
--------	------------------------

Teat Dips & Udder Washes

Neogen's Tetradyne line of pre-dips, post-dips and udder washes help producers combat the economic implications of mastitis. Mastitis not only can result in production loss, but can also effect reproductive efficiency. Our line has a variety of actives and conditioners allowing the dairyman to select the best products to meet his herd health goals and climate conditions.

Iodine Teat Dips (NPE-free)

NU-DYNE Teat Dips are formulated without the use of Nonylphenol Ethoxylates (NPEs) to provide environmentally safe products that eliminate possibilities of NPE residues in milk.

A

Nu-Dyne 102

1% iodine, 2% glycerin, based teat dip solution

Item No.	Available Sizes
----------	-----------------

680031	15 gal, 30 gal, 55 gal, 250 and 275 gal totes
--------	---

B

Nu-Dyne 110

1% iodine, 10% glycerin, based teat dip solution

Item No.	Available Sizes
----------	-----------------

680031	15 gal, 30 gal, 55 gal, 250 and 275 gal totes
--------	---

Teat Dips & Udder Washes (cont.)

C

Nu-Dyne 502

0.5% iodine, 2% glycerin, based teat dip solution

Item No.	Available Sizes
----------	-----------------

680034	30 gal, 55 gal, 250 gal tote
--------	------------------------------

D

Nu-Dyne 505

0.5% iodine, 5% glycerin, based teat dip solution

Item No.	Available Sizes
----------	-----------------

680033	55 gal, 250 and 275 gal totes
--------	-------------------------------

E

Nu-Dyne 7575

0.75% iodine, 7.5% glycerin, based teat dip solution

Item No.	Available Sizes
----------	-----------------

603131	275 gal tote
--------	--------------

Hydrogen Peroxide Teat Dips

Fizzing action makes a good pre-dip, the hydrogen peroxide is sensitive to sunlight and extreme weather, it has a shorter shelf life than Iodine Teat Dips

A

Oxipro

A 1% hydrogen peroxide, 10% glycerin, teat dip solution

Item No.	Available Sizes
----------	-----------------

602126	1 gal, 5 gal, 15 gal, 30 gal, 55 gal, 250 and 275 gal totes
--------	---

B

Oximate

A 0.5% hydrogen peroxide, 5% glycerin, teat dip solution

Item No.	Available Sizes
----------	-----------------

602262	55 gal, 250 gal tote
--------	----------------------

Caprylic/Capric Acid Teat Dip

Organic Acid Teat Dip

A

Dermapro

A 1% caprylic/capric acid blend and 40% propylene glycol teat dip. For extreme winter weather conditions.

Item No.	Available Sizes
----------	-----------------

602259	1 gal, 5 gal, 15 gal, 30 gal, 55 gal, 250 and 275 gal totes
--------	---

Bronopol Teat Dip



Windpro

A 0.2% bronopol, 80% emollients, teat dip for extreme winter weather conditions.

Item No.	Available Sizes
603044	275 gal tote

Barrier Teat Dips



Nu-Force

A 1% iodine, with 10% glycerin, barrier teat dip with a very low drip technology.

Item No.	Available Sizes
633452	5 gal, 15 gal, 55 gal, 250 and 275 gal totes



Tetra Kote

A 0.2% bronopol, 10 glycerin, barrier teat dip with a very low drip technology.

Item No.	Available Sizes
603333	15 gal, 55 gal, 250 gal tote

Udder Washes



Nu-Udder

a 1.75% iodine and phosphoric acid udder wash. Pre-mix one (1) ounce of NU-UDDER with five (5) gallons of water for 25 ppm available iodine. Use a separate towel for each cow and discard towel after applications, then rinse with warm water and examine each quarter with strip cup.

Item No.	Available Sizes
604191	1 gal, 15 gal, 30 gal, 55 gal

Do YOU have a plan to prevent mastitis?

The National Mastitis Council's 10-Point Program:

1. Improve general udder health management at the farm level to decrease the pressure of infection with udder pathogens from older cows to heifers.
2. Control for cross-suckling in calves and young stock.
3. Implement an effective and efficient fly control system.
4. Keep young and primigravid heifers in a clean and hygienic environment and separate from multiparous animals - provide as much attention to this group of animals related to hygiene and cleanliness as spent on lactating animals.
5. Avoid any nutritional deficiency - monitor vitamin E and selenium levels when any doubt exists, especially in relation to clinical mastitis. Zinc, copper and vitamin A play a role as well and could be checked if there is doubt.
6. Minimize the risk of negative energy balance before and after calving through appropriate transition feeding systems.
7. Reduce the incidence of udder edema through optimized peripartum management.
8. Minimize stress around calving (e.g. by not moving heifers to the calving pen when already in labor) and minimize incidence of dystocia and peripartum disease.
9. Consider use of internal teat sealants prepartum where there is a high risk of environmental mastitis in the peripartum period.
10. Use prepartum antibiotic treatment in heifers under certain conditions only:
 - a) under the supervision of the herd veterinarian, within the context of a valid veterinary/client/patient relationship;
 - b) after quantification of the problem and identification of major pathogens (not coagulase-negative staphylococci) as the cause through culturing;
 - c) choice of the antibiotics should be based on antimicrobial susceptibility testing;
 - d) test for residues before every milk delivery;
 - e) upgrading of management at the same time - discontinue treatment as soon as new management strategies become effective.

Dairy Biosecurity

Insect Control • Rodent Control • Specialty Disinfectants



Dairy Biosecurity

Insect Control

A

Gold Stick™ Fly Traps

- Contains a very effective attractant designed to attract multiple fly species using a combination of food baits
- Attractants are incorporated into the glue, and are cherry-scented
- The color gold has been proven to draw flies, and reflective properties of the metallic surface causes an "open window of light" effect
- To use, simply place traps on window sills or hang them vertically. For use in homes, garages, offices, stables, barns and near garbage cans or containers. Traps may also be used in USDA and FDA inspected facilities.

Item No.	Description	Case qty
963	24" Gold Stick with bait packed 24 traps/display case	24
912	10½" Gold Stick with bait packed 12 traps/display case	12
912R4	10½" Gold Stick with bait 4/pk	24

A



B

Clear Bug and Fly Window Trap

Catchmaster's Clear Bug and Fly Window Trap is safe, non-toxic and easy-to-use. The nearly invisible trap mounts quickly to the window and traps flies where they hang out the most.

Item No.	Description	Case qty
904	Clear Bug and Fly Window Trap 4/pk, 24/display case	24

B



C

Scented Bug and Fly Catcher Fly Ribbon

Specially formulated and scented, these bug and fly catchers are for household, farm and non-food commercial use. Measures 1½" x 25".

Item No.	Description	Case qty
9144M4	Fly Ribbon 4/pk	24
9144B4	Fly Ribbon Bulk 96/pk	4

C



D

Fly Bag Trap

Our Fly Bag Trap is easy to use, just add water and the attractant dissolves. This specially formulated lure is designed to attract a broad range of fly species and is long-lasting. Features a safety locking cap.

Item No.	Description	Case qty
975-12	Fly Bag Trap	12

D



Did you know?

Dense horn fly populations can negatively impact milk production in pastured cows by 20 percent. †

When fly populations reach high levels, normal grazing patterns are altered as cattle attempt to gain relief from horn fly infestation and the following can be observed: ††

- Less feeding time
- More traveling
- More tail switching
- Congregating in groups
- Congregating in water



E Spider Web™ Fly Glue Trap

One Spider Web trap can catch more than 100,000 flies! With over 6,000 square inches of surface area, this double-sided fly trap was designed to tackle the most severe fly infestations. Attractants include food grade, multi-bait, and a fluorescent chartreuse color. University tests have shown that when the Spider Web Fly Glue Trap is used at a rate of one trap per 600 square feet, high infestation areas were able to achieve 70–80% control without any use of pesticides.

Item No.	Description	Case qty
930	Spider Web Fly Glue Trap	12

E



F Giant Fly Trap Roll

One-sided adhesive sheet with 3,600 square inches of fly catching surface. Each roll is 30' long and features a pre-baited scent as well as an alluring fluorescent chartreuse color. Use in animal health facilities, barns, waste rooms and other high infestation areas.

Item No.	Description	Case Ct.
931	Giant Fly Trap Roll	12

F



G Giant Fly Glue Trap

One-sided adhesive board with capacity to hold thousands of flies. 24" x 12". For use in barns. Environmentally safe, non-poisonous, long lasting and easy to use.

Item No.	Description	Case Ct.
948	Giant Fly Glue Traps	48

G



H Fly Control String

Best Value! Non-toxic, environment friendly, the trap works all year round in the stable, milking room and barn. The roll with fly repellent is placed at ceiling height. When the string is full, replace it with the refill. Refill fits any other holder on the market.

Code	Description	Count	Case
4999-1050-184	Fly Control String 500m w/Hardware	1	1
4999-1050-185	Fly Control String 500m Refill	1	1

H



I

I Fly Trap Ribbon

Odorless and eco-friendly fly trap for the home in classic spiral form. Ensures a pleasant home environment free of unpleasant and annoying flies. The long-acting adhesive traps flies and other insects quietly and unobtrusively. Active day and night.

Code	Description	Count	Case
4999-1050-187	Silvalure Spiral Ribbon 6/pk	6	1

Specially formulated and scented, these bug and fly catchers are for household, farm and non-food commercial use. Measures 1.5 x 25in.

Code	Description	Count	Case
4999-1055-020	Catchmaster Hanging Fly Ribbon 4/pk	4	24

I



J

J Fly Trap Roll

An effective non-toxic, environmentally friendly and compostable fly paper for stables, milking rooms and barns. This roller is extra effective due to the patented 3D pattern with fluorescent colors. Hang fly trap on a nail or a hook. Pull out the required catching surface. When the catching surface is covered with flies, pull out another section. Roll up the used surface and cut it off with a sharp knife.

Code	Description	Count	Case
4999-1050-048	Silvalure Fly Roll 6m	12	1
4999-1050-088	Silvalure Fly Trap/Curtain 9m Roll	1	1

One-sided adhesive sheets with 3,600sq. in. of fly catching surface. Each roll is 30ft long and features a pre-baited scent as well as an alluring fluorescent chartreuse color. Use in animal health facilities, barns, waste rooms, and other high infestation areas.

Code	Description	Count	Case
4999-1055-017	Catchmaster Giant Roll 30ft	1	12

J



4999-1050-048



4999-1055-017

K

K Screw Worm and Ear Tick Aerosol

- Prozap Screw Worm / Ear Tick Aerosol provides wound protection from flies and maggots
- Contains .5% Permethrin
- Contains violet marking dye to indicate treated animals and uniform coverage
- Controls maggots, flies, screw worms, ticks (including ear ticks), gnats, lice and other insects

Item No.	Description	Case Ct.
1002520	Prozap Screw Worm and Ear Tick Aerosol 12oz	12

K



Insect Control (cont.)

Prozap provides a complete line of aerosols, ready-to-use liquids, concentrates and dust products to meet the needs of livestock producers, horse owners, pet owners and professional pest control operators alike. Whether you are spraying your yard for mosquitoes, controlling horn flies on cattle or combating pesky stable flies on horses, Neogen's Prozap line has you covered. Utilizing proven active ingredients including Pyrethrin, Permethrin and Vapona, Prozap provides the end user several choices of control to solve any insect problem.

L Dy-Fly[®] Aerosol

- Dy-Fly Aerosol Insecticide provides instant knock-down and kill of flying and crawling insects in homes and on farms
- Contains .5% Pyrethrin and 5% PBO
- For use as a premise spray or directly on animals
- Controls flies, mosquitoes, gnats, moths, ants, hornets, wasps, spiders, roaches and other insects
- For use in dairies, animal quarters, milk rooms and poultry houses
- Approved for use in homes and food processing areas

Item No.	Description	Case Ct.
0693510	Prozap Dy-Fly Dairy Aerosol 20 oz	6
0690010	Prozap Dy-Fly Dairy Aerosol 25 oz	6

L



M LD-44[®]Z

- LD-44Z Insect Fogger kills and repels Flies, Mosquitoes and Lice
- Contains .5% Pyrethrin and 4% PBO
- Controls flies, mosquitoes, wasps, gnats, lady Asian beetles, roaches, spiders, plus 19 other flying and crawling insects
- For use in barns, milk rooms, parlors and other buildings

Item No.	Description	Case Ct.
1453510	Prozap LD-44Z Insect Fogger 20 oz	6
1450010	Prozap LD-44Z Insect Fogger 25 oz	6

M



N

CT-75 Dairy Aerosol

- CT-75 Dairy Aerosol provides immediate and effective control of insects
- Contains .7% Pyrethrins, 5% PBO
- For use as a fogger in milking parlors, milk rooms, barns, food processing areas and in stored product spaces
- Can be used around, and directly on, lactating and non-lactating dairy cattle
- Controls house flies, horn flies, stable flies, gnats, mosquitoes, small flying moths and other insects

Item No.	Description	Case Ct.
0720210	Prozap CT-75 Dairy Aerosol 26 oz	6

N





Pro-Mist'r CT-7 Metered Dispenser

- For use with Prozap LD-44T™ Metered Insecticide or Prozap Fragrances
- Features power switch display, 24 hour or day only operation and three spray interval selection
- When set at 15 minute intervals will provide up to 30 days of coverage per refill
- Accepts most metered aerosols
- Uses “D” size batteries

Item No.	Description	Case Ct.
CT79500	ProMist'r Dispenser	6



LD-44T™ Metered Insecticide Refill

- Contains 1% Pyrethrins, 2% PBO and 3% 264
- 6.5 oz can lasts up to 30 days in the Pro-Mist'r Metered Dispenser
- Covers 6,000 cubic feet of space
- Fits most automatic dispensers
- Controls flies, mosquitoes, gnats and moths
- For use in food warehouses, dairies, barns and parlors

Item No.	Description	Case Ct.
73010	Prozap LD-44T Metered Insecticide Refill 6.5oz	12



Insectrin® X Concentrate

- Insectrin X Concentrate is a broad spectrum, multi-use insecticide that kills fast and has residual action
- Contains 10% Permethrin
- For use on livestock, animal premises, lawns and ornamentals
- **Approved for use on lactating and non-lactating dairy cattle**
- Mix with water or oil for use as a spray
- Mix with oil for cattle backrubber use to control horn flies, face flies, horseflies, ticks and ear ticks

Item No.	Description	Case Ct.
1038510	Prozap Insectrin X Concentrate 8oz	12
1037510	Prozap Insectrin X Concentrate 32oz	6
1037010	Prozap Insectrin X Concentrate 1 gallon	4



Vapona 400E Concentrate

RESTRICTED USE

- Contains 44.5% DDVP (Vapona)
- For use on dairy cattle and their premises to control flies, gnats and mosquitoes
- For use as a fog and mist in outdoor applications and in non-food warehouses

Item No.	Description	Case Ct.
0176010	Prozap Vapona 400E (HAZMAT) 2.5 gallon Restricted Use	2



Evergreen EC 60-6

- Multi-purpose insecticide that contains pyrethrins, a botanical insecticide
- Contains 6% Pyrethrins and 60% PBO
- For use in barns, dairies, milking parlors, milk rooms and poultry houses
- Controls most flying and crawling pests

Item No.	Description	Case Ct.
5069510	Evergreen Emulsified 60-6 32oz	6



Insect Control (cont.)

T PyGanic Livestock and Poultry Insecticide

- OMRI-certified organic pyrethrum concentrate
- Contains 1.4% Pyrethrins
- Controls most flying and crawling pests on livestock and poultry and in pet quarters or pet bedding
- For use as a livestock and poultry spray
- For use in barns, dairies, milking parlors, milk rooms and poultry houses

Item No.	Description	Case Ct.
7047510	Prozap PyGanic Livestock Spray 32 oz	6



U Aqueous Fly Spray

- Ready-To-Use water based insecticide for use on cattle to control flies, mosquitoes and gnats
- Contains 1% Pyrethrins and 1% PBO
- Leaves no oily residue
- For use as a spray or fog in barns, food processing areas and homes to control roaches, ants, silverfish, spiders and other insects

Item No.	Description	Case Ct.
1217010	Prozap Aqueous Fly Spray 1 gallon	4
1216010	Prozap Aqueous Fly Spray 2.5 gallon	2



1217010

1216010

V Prozap® Insectrin CS

- Insectrin CS is an oil-based ready-to-use insecticide for effective control of flies, lice, sheep keds, mosquitoes and ticks on dairy cattle
- Contains 7.4% Permethrin and 7.4% PBO
- Ready to use as a pour-on, wipe-on and spray on animals or as a spot or premise spray
- Mix with mineral oil for backrubber use on cattle
- Approved for use on lactating dairy cattle

Item No.	Description	Case Ct.
0518010	Prozap Insectrin CS 16oz	12
0517010	Prozap Insectrin CS 1 gallon	4
0516010	Prozap Insectrin CS 2.5 gallon	2



0518010

0516010

0517010

W Insectrin® 1% Pour-on Xtra

- Ready-To-Use as a pour-on, spray or mist
- Contains 1% Permethrin and 1% PBO
- For use on lactating and non-lactating dairy cattle, beef cattle and calves
- Controls lice, horn flies, face flies, horse flies, stable flies, house flies, mosquitoes and black flies
- Mix with CT Neutral oil (p.78) oil for use with backrubbers
- For use on sheep to control sheep keds and lice
- Use as a spot spray or premise spray in and around animal premises, kennels and outside meat processing premises

Item No.	Description	Case Ct.
1517010	Prozap Insectrin 1% Pour-On Xtra 1 gallon	4
1516010	Prozap Insectrin 1% Pour-On Xtra 2.5 gallon	2



1517010

1516010

X**Backrubber and Pour-On**

- Ready-To-Use permethrin insecticide to be applied directly or with the use of back rubbers to livestock
- Contains .125% Permethrin
- For use on beef cattle, dairy cattle (lactating and non-lactating) and swine
- Controls flies, mosquitoes, ticks and lice

Item No.	Description	Case Ct.
0896010	Prozap Backrubber and Pour-On 2.5 gallon	2

X**Y****Backrubber and Pour-On Xtra**

- Ready-To-Use synergized insecticide to be applied directly or with the use of backrubbers to livestock
- Contains .125% Permethrin and .125% PBO
- For use on dairy cattle (lactating and non-lactating)
- Controls flies, mosquitoes, ticks and lice

Item No.	Description	Case Ct.
0966010	Prozap Backrubber and Pour-On Xtra 2.5 gallon	2

Y**Z****Beef and Dairy RTU**

- Ready-To-Use animal and premise Vapona insecticide that can be applied by spray or fog
- Contains 1% Vapona
- For use on dairy cattle (lactating and non-lactating), goats and sheep
- For use in and around horse barns, dairy barns, shelters, milk rooms, feedlots and stockyards
- Controls horn flies, house flies, stable flies, face flies gnats and mosquitoes

Item No.	Description	Case Ct.
1147010	Prozap Beef and Dairy RTU 1 gallon	4
1146010	Prozap Beef and Dairy RTU 2.5 gallon	2

Z

1146010

1147010

AA**Dairy Cattle Spray**

- Ready-To-Use fly spray for use on lactating and non-lactating dairy cattle
- Contains .05% Pyrethrins, .1% PBO and .5% DDVP (Vapona)
- Controls flies, mosquitoes, gnats and lice

Item No.	Description	Case Ct.
1577010	Prozap Dairy Cattle Spray 1 gallon	4
1576010	Prozap Dairy Cattle Spray 2.5 gallon	2

AA

1576010

Insect Control (cont.)



Dairy and Ranch Insect Spray

- Dairy and Ranch Insect Spray is a versatile Ready-To-Use oil-based animal and premise spray
- Contains .1% Pyrethrins and 1% PBO
- For use on dairy cattle (lactating and non-lactating), calves and their premises
- May also be used as a fogger
- Provides rapid knockdown and kill of flies, gnats and mosquitoes
- **Safe for calves**

Item No.	Description	Case Ct.
1537010	Prozap Dairy and Ranch Spray 1 gallon	4
1536010	Prozap Dairy and Ranch Spray 2.5 gallon	2



1536010



VIP Insect Spray

- Ready-To-Use animal and premise spray that contains Vapona and Synergized Pyrethrins
- Contains .025% pyrethrins, .25% PBO and .5% DDVP (Vapona)
- Kills and repels horn flies, house flies, mosquitoes and gnats
- For use on cattle and their premises

Item No.	Description	Case Ct.
1087010	Prozap VIP Insect Spray 1 gallon	4
1086010	Prozap VIP Insect Spray 2.5 gallon	2



1086010

1087010



Dust Bag Kit

- The Prozap Dust Bag kit comes with a refillable dust bag and 12.5 pound Insectrin Dust cartridge of .25% Permethrin
- Dust Bag that can be hung for direct application to animals
- Controls face flies, horn flies, northern fowl mites, lice, fleas and ticks

Item No.	Description	Case Ct.
1499610	Prozap Insectrin Dust Bag Kit 1 kit	2



Insectrin® Dust Refill

- The Insectrin Dust Refill contains .25% Permethrin for use with the Dust Bag for direct application to animals
- Controls lice, flies, northern fowl, mites, fleas, and ticks found in bedding, cracks, and crevices

Item No.	Description	Case Ct.
1499510	Prozap Insectrin Dust 2-Pack 12.5lb (2 pack)	1
1499550	Prozap Insectrin Dust Bulk 20lb Pail	1



1499510

1499550





Dust Bags

- High quality Dust Bag can be hung for direct application to animals
- Easy to fill with Insectrin Dust

Item No.	Description	Case Ct.
5029510	Prozap Dust Bag 1 bag	10



Insect Guard

- Easy-to-use pest strip for use in general spaces
- 18.6% Vapona for fast and effective control
- Kills flies, gnats, mosquitoes, moths and various crawling insects
- Controls insects up to 4 months
- One Insect Guard strip treats up to 1200 cubic feet
- For use in un-occupied areas in the home, such as garages, attics, crawl spaces, sheds and basements
- For use in barns, stables, tack rooms, kennels, and other farm buildings
- Controls pests in raw grain bulk storage and garbage collection areas

Item No.	Description	Case Ct.
5019510	Prozap Insect Guard 80g	12
5019550	Prozap Insect Guard 80g 36pk display	36
5019530	Prozap Insect Guard 80g 85 pack bulk	85
5019520	Prozap Insect Guard 80g 4x12 Clip Strip	48



Prozap® Bovi-Rub

The Prozap Bovi-Rub back rubber is designed for effective and economical control of flies, grubs, lice and ticks on cattle and other livestock. Superior insecticide charging with wicking action allows for low-stress application of insecticides on cattle and other livestock. Hang near water, mineral feeders or in alley ways to encourage use. Initially charge the Bovi-Rub back rubber with 2.5 to 5 gallons of solution and recharge as necessary to maintain wetness. Use Prozap insecticides for optimal results.

Item No.	Description	Case Ct.
5079610	Prozap Bovi-Rub 10 ft	2
5079710	Prozap Bovi-Rub 5 ft	4



Prozap® Bovi-Bullets

The Prozap Bovi-Bullet face rub is designed for effective and economical control of face flies, horn flies, lice and ticks on cattle and other livestock. With a metal ring for easy hanging, the Bovi-Bullet is ideal for use in mineral feeders. Superior insecticide charging and wicking action allows for low-stress application of insecticides on cattle. Initially charge the Bovi-Bullet with 1 liter of solution and recharge as necessary to maintain wetness. Use Prozap insecticides for optimal results.

Item No.	Description	Case Ct.
5079810	Bovi-Bullet 18 in	4



Prozap® Bovi-Strips

The Prozap Bovi-Strips face flaps are designed for use with the Bovi-Rub for effective and economical control of face flies, horn flies, lice and ticks on cattle and other livestock. Simply tie the Bovi-Strips to the Bovi-Rub for additional insecticide application to the face and sides of cattle and other livestock. Superior wicking action allows for low-stress application of insecticides. Use Prozap insecticides for optimal results.

Item No.	Description	Case Ct.
5079910	Bovi-Strips 22/bx	10



Rodent Control

Control rats and mice in and around your facilities

Neogen's Rotational Baiting Program



Did you know that one rat can eat more than 20 pounds of feed per year? Or that rodents carry more than 20 disease causing pathogens for livestock? Farm facilities also suffer when rodents are present, as they can cause serious damage to insulation, structure foundation and electrical wiring.

Major pathogens transmitted by rodents which post a threat to livestock or human health

PATHOGEN	DISEASE	ROUTE OF TRANSMISSION
BACTERIA:		
Leptospira icterohaemorrhagiae	Leptospirosis	Urine
Salmonella typhimurium + enteritidis	Salmonellosis/enteritis	Feces
Treponema hyodysenteriae	Dysentery	Saliva, liquids
Erysipelothrix rhusiopathiae	Erysipeloid	Feces
Listeria monocytogenes	Listeriosis	Feces
Campylobacter jejuni	Dysentery	Feces
Pasteurella multocida	Pasteurellosis	Respiratory tract
Brucella abortus	Brucellosis	Urine
Prototheca zopfii	Mastitis	Feces
Yersinia enterocolitica	Yersiniosis	Feces
VIRUSES:		
Picornavirus	Foot & Mouth Disease	Feces
Herpesvirus	Aujeszky's Disease	Multiple tissues
PROTOZOA:		
Toxoplasma gondii	Toxoplasmosis	Flesh/feces
Cryptosporidium parvum	Cryptosporitiosis	Flesh/feces
PARASITES:		
Trichinella spp.	Trichinosis	Flesh
Capillaria spp.	Capillariasis	Flesh
Toxocara cati	Toxocariasis	Feces
Hymenolepis nana	Rat tapeworm	Feces

A**Ramik® Glue Traps and Glue Boards**

- Non-toxic, disposable and ready-to-use
- Humane traps without poisons
- Premium glue
- Individually packaged with J-hook boxes
- Ramik Glue Traps have a peanut scent that attracts rats and mice—no additional baits needed!

Item No.	Description	Case Ct.
116220	Ramik Mouse Glue Traps 4pk	12
116230	Ramik Rat Glue Traps 2pk	12
	Ramik Mice and Insect Glue Boards 4pk	18

A

116220

116230

B**Ramik® Rodent Bait Station**

- Lockable bait station is tamper-resistant
- Interior vertical rods for securing bait
- Two openings for rodents to enter
- Use with Ramik Mini Bars, Havoc, Di-Kill or CyKill blocks

Item No.	Description	Case Ct.
*000500	Ramik Rodent Bait Station, Bulk	12
000550	Ramik Rodent Bait Station, Retail Pack	6

Sold by Case Qty Only*B****C****Ramik® Multi-Catch™**

- Non-toxic, child and pet safe
- No assembly required
- Can be used with a glue board (1 board included)
- Trap can hold over a dozen mice at a time
- Clear window for easy viewing
- Use as a catch and release trap again and again

Item No.	Description	Case Ct.
945	Ramik Multi-Catch Trap	6

C**D****Ramik® Lures**

- For squirrels, raccoons and rabbits
- Non-poisonous
- Made with food-grade ingredients
- Use in combination with a live trap to capture hard-to-trap animals
- Customized attractive scents for squirrels, raccoons or rabbits

Item No.	Description	Case Ct.
950	Lure for Squirrels 4 oz Jar	10
951	Lure for Raccoons 4 oz Jar	10
952	Lure for Rabbits 4oz Jar	10

D

950

951

952

E**Plastic Bait Station**

Plastic square bait station for use with bait blocks. Includes security ties.

Code	Description	Count	Case
4999-1050-124	Plastic Bait Station 6.5in. x 4.1667in. x 2in.	1	24
4999-1055-081	Rodent Café Bait Station	1	6

E

Rodent Control (cont.)

1st generation anticoagulant: Diphacinone

- Death may occur within 4-5 days after a lethal dose is consumed
- Ramik Green rodenticides are formulated without wax for high palatability and weatherability
- Food quality grain mix
- Configurations include nuggets, mini bars, bars and bait packs

F

Ramik® Green

The Ramik Green bait system uses food processing technology to produce an unusually palatable and highly-attractive bait that retains its freshness, sweetness and effectiveness in a long-lasting nugget form. Nuggets are hot-extruded so they are weather-resistant without the use of wax.

Ramik Green, 1/2"

Item No.	Description	Case Ct.
116336	4 lb resealable pouch	4
116339	15 x 4 lb resealable pouches (display)	1

Ramik Green, 3/16"

Item No.	Description	Case Ct.
116300	20lb bucket	1
116303	50lb box (bulk)	1

F



116336

116300

G

Ramik® Green Bait Packs and Mini Bait Packs

Ramik Green nuggets in convenient, ready-to-use bait packs. No need to touch bait; rodents will gnaw open the packs.

Ramik Green Bait Packs, 1/2"

Item No.	Description	Case Ct.
116341	16 x 4oz bait packs (4lb) resealable pouch	4
116305	60 x 4oz bait packs (15lb) bucket	1

Ramik Green Mini Bait Packs, 3/16"

Item No.	Description	Case Ct.
116316	45 x 1.5oz bait packs (4lb) bucket	4
116319	300 x 1.5oz bait packs (28lb) bulk tub	1

G



116316

116305

116341

116305

H

Ramik® Bars - 16 oz bars

Ramik all-weather bar baits are manufactured utilizing a special proprietary extrusion process, where all the bait ingredients are fully blended, bonded and then shaped into weather-proof bait bars. A small amount of edible wax is added to allow uniform sized bars to be formed. Each 16 oz bar can be used whole, or easily broken into 4 oz pieces or 16 1 oz pieces.

Item No.	Description	Case Ct.
116334	4 x 16oz bars (4lb) box	4

H



116334



Ramik® Mini Bars - 1 oz bars

Ramik Mini Bars are ready to use, and perfect for making multiple bait placements by hanging on wire, pegging, or securing in bait station boxes. They are also just the right size to use in small openings where rodents live and travel.

Item No.	Description	Case Ct.
116331	64 x 1 oz (4 lb) pouch	4
116332	64 x 1 oz (4 lb) pail	4
116345	144 x 1 oz (9 lb) pail	4
116350	320 x 1 oz (20 lb) bucket	1
116326	640 x 1 oz (40 lb) tub	1
116329	300 x 1 oz (50 lb) tub	1



116345

116332



Ramik® Mouser Refillable Bait Station

The Ramik Refillable Bait Station is a great option for the homeowner looking for an effective rodent control solution. The package includes a refillable bait station and mini bars. The Ramik mini bars contain a proven and effective anticoagulant rodenticide and will be kept securely inside the bait station. The station's two small openings allow easy access for mice to enter and feed — but prohibit access to children.

- EPA compliant child resistant refillable bait station
- Contains Ramik Mini Bars
- Easy to use bait station
- Resealable pouch packaging displays great on the shelf and keeps the bait fresh

Item No.	Description	Case Ct.
000800	Ramik Refillable Bait Station 8oz	6
000900	Ramik Refillable Bait Station 16oz	6



000800

000900



Ramik® Green AG

RESTRICTED USE

The Ramik Green AG rodenticide combines superior palatability and weather resistance with the proven active ingredient diphacinone to control Norway rats, roof rats, house mice, California ground squirrels, pocket gophers, moles & voles in a wide variety of field applications.

Item No.	Description	Case Ct.
116310	Ramik Green AG 20lb Pail	1
116320	Ramik Green AG 40lb Tub	1



116310

116320



Ramik® Oats

RESTRICTED USE

Ramik Oats is a food-grade bait that mimicks squirrels natural food source. For control of California ground squirrels ONLY.

Item No.	Description	Case Ct.
116390	Ramik Oats 30lb bucket	1



Rodent Control (cont.)

Second generation anticoagulant: Brodifacoum

Brodifacoum is the strongest anti-coagulant rodenticide available. Havoc products combine brodifacoum with a special mixture of highly attractive bait ingredients along with patented food processing techniques. The result is a superior, single-feed rodenticide in a unique bait delivery system.

- Controls Norway rats, roof rats and house mice —may kill both rats and mice in a single night's feeding
- Available in chunks, pellets, block and meal bait configurations
- XT-Block Contains Bitrex[®], a child and non-target deterrent

M Havoc[®] Attack Blocks

- Highly palatable, second generation anticoagulant specially formulated for use by livestock and poultry producers.
- Unique blend of emulsifying agents that allow for a better blend (which equals higher palatability) of ingredients.
- All-weather bait block with great heat tolerance

Item No.	Description	Case Ct.
116393	Havoc Attack Blocks 10lb Bucket	4
116394	Havoc Attack Blocks 20lb Bucket	1



N Havoc[®]-XT Blok

- Weather-resistant blocks
- Unique shape makes it easy for rats and mice to gnaw on
- Available in a resealable pouch, designed to maintain bait freshness
- Larger bulk sizes available for frequent use

Item No.	Description	Case Ct.
116362	Havoc-XT Blok 8lb resealable pouch	4
116361	Havoc-XT Blok 10lb pail	4
116369	Havoc-XT Blok 20lb pail	1



116362

116369

O Havoc[®] Rodenticide Bait

The food-grade ingredients in Havoc Rodenticide Bait provide superior palatability to deliver brodifacoum. This meal bait product contains food-grade ingredients, seeds and grains, which provide rodents a variety of textures and flavors.

Specially formulated bait that includes highly palatable food-grade rolled oats

Just a teaspoon amount will control house mice, Norway rats and roof rats

- Contains 0.005% Brodifacoum- strongest single feed second generation active available
- Meal baits are excellent for use where competing food or feed sources are present
- Use as a supplement to Neogen's recommended Rotational Baiting Strategy - during periods of heavy rodent infestation.

Item No.	Description	Case Ct.
116395	Havoc Rodenticide Bait 25lb Bag	1
116398	Havoc Rodenticide Bait 25lb Pail	1
116396	Havoc Rodenticide Bait 50lb Bag	1



116395

116398



Acute Toxicant: Bromethalin

Bromethalin was developed to combat a world-wide perceived problem of rodent resistance to warfarin-like anticoagulant rodenticides. A highly potent neurotoxin rodenticide that provides a lethal dose to rodents in a single feeding. Bromethalin attacks the central nervous system; rodents usually consume a lethal dose within a single night's feeding, with the first dead rodents appearing within 2 days. Available in bait blocks or place packs.

- Fast acting—bait today and see results tomorrow!
- Palatable bait is preferred over most feeds, food sources and competitive baits
- Rodents stop feeding after consuming a lethal dose; this results in a consumption of 80% less bait than with traditional baits
- No known resistance, neurotoxicant formulation
- Reduced risk of secondary toxicity
- Use as part of Neogen's recommended Rotational Baiting Program



CyKill™ Place Packs (Pellets)

- Paper pouches contain pellets for effective rodent control
- No need to open pouches; rodents eat through the package
- Each pouch contains .75oz of pelleted bait

Item No.	Description	Case Ct.
112835	CyKill .75oz Place Packs 100 pks/pail	4



CyKill™ Blocks

- Multiple gnawing edges
- Highly palatable formulation
- Blocks may be placed in sewers and other damp environments

Item No.	Description	Case Ct.
112830	CyKill 0.75oz Blocks 9lb pail 192 count	4
112825	CyKill 0.75oz Blocks 4lb pouch 86 count	4



Rodent Control (cont.)

Second Generation Anticoagulant: Bromadiolone

Neogen's newest rodenticide bait includes the active Bromadiolone, a proven and effective second generation active. Rats, mice and meadow voles may consume a lethal dose in a single night's feeding, with the first dead rodents appearing four to five days after feeding begins.

R DeciMax® Blocks

- All-weather formulation reduces the risk of ruined bait
- Food grade ingredients including grains and seeds provide an irresistible formulation for effective control in most environments
- Ridges on 1 oz blocks encourages gnawing and improves consumption

Item No.	Description	Case Ct.	Pallet Qty.
116850	DeciMax Blocks 144 x 1 oz (9 lb) Pail	4	80
116855	DeciMax Blocks 288 x 1 oz (18 lb) Pail	4	36

S DeciMax® Place Packs

- Place packs offer a convenient no-touch bait placement for hard to reach areas
- Pellets inside packs are formulated with food grade material to improve palatability
- 8 lb pail offers 86 - 1.5 oz place packs

Item No.	Description	Case Ct.	Pallet Qty.
116845	DeciMax Pellets (86 x 1.5 oz) PP (8 lb) Pail	4	80

T DeciMax® Soft Bait

- Highly palatable soft bait manufactured with the highest quality food grade ingredients
- Soft baits are made without wax to ensure more active per placement and high acceptance
- High performance in cold or hot weather conditions
- 10 gram sachets are packaged inside plastic bags within pail to maintain freshness

Item No.	Description	Case Ct.	Pallet Qty.
116841	DeciMax Soft Bait 8 lb Pail	4	144
116840	DeciMax Soft Bait 22 lb Pail	1	48



Zinc Phosphide Tracking Powder

Tracking Powder Baits are designed to be picked up on the foot pads, fur, and/or tails of rodents during their travels and ingested during the rodent's daily grooming activities. Prozap Tracking Powder is a formulation of 10% Zinc Phosphide and corn starch which is an excellent carrier that adheres to the rodent effectively. Acute toxicants like Zinc Phosphide, require only one grooming to kill and quickly reduce rodent populations when a tolerance to anticoagulants exists.



Prozap Zinc Phosphide Tracking Powder

RESTRICTED USE PRODUCT

- Powerful tracking powder using the acute active of 10% Zinc Phosphide
- Just teaspoon amounts will control Mice
- Rodents ingest toxicant while grooming making tracking powder an excellent tool when a tolerance to anticoagulants exists
- Tracking powder works especially well when rodents have extensive food supplies or will not accept other baits
- Dead rodents could appear within hours

Item No.	Description	Case Ct.	Pallet Qty.
116850	DeciMax Blocks 144 x 1 oz (9 lb) Pail	4	80
116855	DeciMax Blocks 288 x 1 oz (18 lb) Pail	4	36



Rodent Control (cont.)

1st generation anticoagulant: Warfarin

Microencapsulated warfarin, a hydroxycoumarin anticoagulant rodenticide, is contained in all Rodex bait formulations. In early research trials, rat acceptance of microencapsulated warfarin baits was 3 to 10 times greater than uncoated warfarin baits. This anticoagulant is a multi-feed chronic rodenticide, and is considered the lowest hazard to non-target animals of any anti-coagulant rodenticide. Rodex bait formulations are available in pellets and blocks.



Rodex™ Pelleted Bait-1

- Kills rats and mice; reduced risk to non-target animals
- Micro-encapsulated warfarin reduces bait shyness
- Available in a resealable pouch to maintain bait freshness

Item No.	Description	Case Ct.
116348	Rodex Pelleted Bait-1 4lb resealable pouch	4



Rodex™ Blox-1™

- Kills rats and mice; reduced risk to non-target animals
- Micro-encapsulated warfarin block is moisture-resistant
- Each 1 lb block breaks easily into smaller pieces
- Convenient “grab and go” 4lb box

Item No.	Description	Case Ct.
116349	Rodex Blox-1 4x16oz bars	4



A 1,000 cow herd with 5% rodent contamination loses more than \$85,000 in feed contamination every year†.

Use Neogen’s 4-step program to control rodents in and around your facilities.

Step 1. Prevent: Clean, clear, and implement preventative measures.

Step 2. Identify: Find the location and severity of the problem.

Step 3. Execute: Implement baiting strategy according to target rodents and locations.

Step 4. Monitor: Monitor the effectiveness of your program with record keeping. Frequency of baiting should change with increased activity.

†Costs of Major Inputs National Average Dairy Feed Costs.” Monthly Data. N.p., n.d. Web. 23 Feb. 2015.



Specialty Disinfectants

A

BioSentry® Universal Barn Cleaner

BioSentry Universal Barn Cleaner is a biodegradable, effective general-purpose cleaner for use dairy barns, farm premises and hutches. Compatible in use with phenolic, quaternary, chlorinated, peroxide and iodine disinfectants. Quickly removes grime, grease, protein and fatty oils.

Active: Surfactant and chelating agent

Use: General purpose alkaline foaming cleaner for farm premise and housing facilities

Activity: Removes grime, grease, proteins and fatty soils

Application: Foaming, high pressure washing or manual cleaning

Item No.	Description	Case Ct.
D12568757	BioSentry Universal Barn Cleaner 1 Gallon	4
D12205602	BioSentry Universal Barn Cleaner 5 Gallons	1
D12205613	BioSentry Universal Barn Cleaner 55 Gallons	1

A



B

Synergize®

Synergize is a multi-purpose disinfectant-cleaner formulated for use in animal and poultry housing facilities. It is also formulated for use on the following equipment in these facilities: waterers, feeders, hauling vehicles and equipment, farrowing barns, nurseries, blocks, creep areas and chutes. Synergize is also for use in farm premise, equine facilities, calf pens and farm vehicles.

Active: Quaternary ammonium/glutaraldehyde

Use: Veterinary clinics, animal care facilities, calf pens, vehicles, etc.

Activity: Kills gram-negative and gram-positive bacteria, viruses and fungi

Application: Mechanical sprayer, fogging, soaking, use in boot baths and vehicles

Item No.	Description	Case Ct.
433600/1	Synergize 1 Gallon	4
433600/2.5	Synergize 2.5 Gallon Pail	2
433600/5A	Synergize 5 Gallon Pail	1
433600/30	Synergize 30 Gallon Drum	1
433600/55	Synergize 55 Gallon Drum	1
433600/275	Synergize 275 Gallon Tote	1

B



SYNERGIZE BOOT BATH MIXING PROTOCOL:

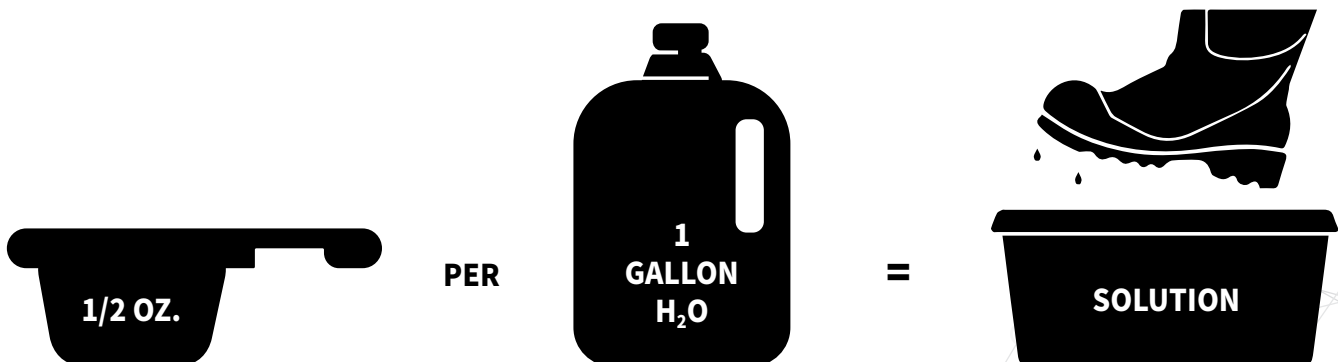

Health & Wellness

**Water Treatment • BVD Testing • Calf Care • Oral Treatments & Drenching
Needles & Syringes • Wound & Surgical Supplies • Castration & Dehorning
Hoof Health • Handling & Identification**

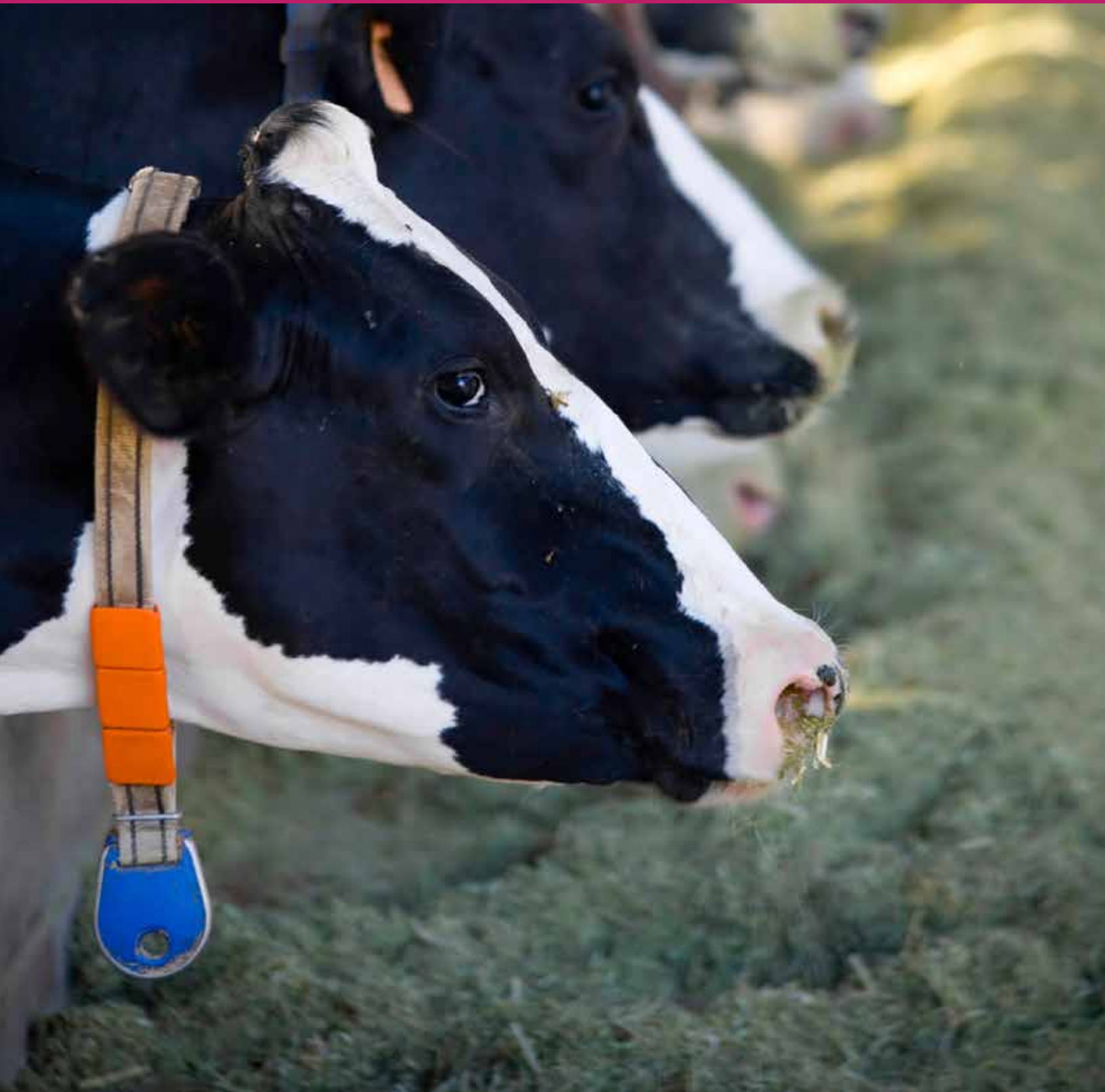

Health & Wellness

Water Treatment

Did you know?

Managing water quality and quantity is one of the most overlooked management practices in livestock production. Clean water plays an important role in digestion and nutrient absorption, and is essential for many physiochemical reactions needed for optimal growth and production.



A

NeoKlor™

AquaPrime® NeoKlor is a 7.5% Sodium Chlorite solution that is EPA approved for usage in potable water disinfection. AquaPrime® NeoKlor has numerous uses in potable water, can be utilized for food plant process, poultry process water, CIP disinfection, industrial cooling water, and wastewater systems.

Active: Sodium Chlorite

Use: Disinfection of potable water found on poultry, swine, and cattle production sites, dairies, food plant processing, poultry process water, industrial cooling

Application: Closed generation system, acid-chlorite chlorine dioxide systems, or other potable water applications.

A



Item No.	Description	Case Ct.
480012/5	NeoKlor 5 Gallon Pail	1
480012/30	NeoKlor 30 Gallon Drum	1
480012/55	NeoKlor 55 Gallon Drum	1
480012/275	NeoKlor 275 Gallon Tote	1

B

BioSentry® AquaPrime® Activator

Biosentry AquaPrime Activator is a special blend of mineral and organic acids specifically formulated to activate Anthium Dioxide® for the disinfection of livestock drinking water. Formulated specifically for use with 5% stabilized sodium chloride solutions to maximize conversion. An easy 1 part activator to 2 parts 5% sodium chloride solution mix will give an over 90% conversion to free ClO_2 . Efficient conversion creates a least cost application when calculating treatment cost per gallon of water or per animal. Liquid is ready to use and includes a green color to indicate presence in injection lines to ensure proper proportioning.

B



Item No.	Description	Case Ct.
142250	AquaPrime Activator 5 Gallon Pail	1
142550	AquaPrime Activator 15 Gallon	1
142650	AquaPrime Activator 30 Gallon Drum	1
142350	AquaPrime Activator 55 Gallon Drum	1
142350	AquaPrime Activator 275 Gallon Tote	1

Water Treatment (cont.)



BioSentry® AquaPrime® Trigger

AquaPrime® Trigger is a water-soluble acidifier for poultry and livestock drinking water. AquaPrime Trigger is a GRAS proprietary blend of mineral acids formulated to reduce pH in drinking water on poultry and livestock farming operations.



Item No.	Description	Case Ct.
488018/5	AquaPrime Trigger 5 Gallon Pail	1
488018/15	AquaPrime Trigger 15 Gallon	1
488018/55	AquaPrime Trigger 55 Gallon Drum	1
488018/275	AquaPrime Trigger 275 Gallon Tote	1



Peraside™

Peraside is an EPA-approved peroxyacetic acid-based sanitizer/disinfectant that is approved for use on food-contact surfaces and equipment — providing the safe alternative to bleach, chlorine and quaternary disinfectants in food processing environments. Peraside is labelled, and proven effective, against a wide variety of human pathogens.



Item No.	Description	Case Ct.
406047/2.5	Peraside 2.5 Gallon Pail	1
406047/5	Peraside 5 Gallon Pail	1
406047/30	Peraside 30 Gallon Drum	1
406047/55	Peraside 55 Gallon Drum	1

Disease Diagnostics

Production of PI Calves: Two Routes of Transmission

More common route
(Over 90%)

Susceptible pregnant female (non-PI) infected with BVDV at about 1.5-4 months of gestation

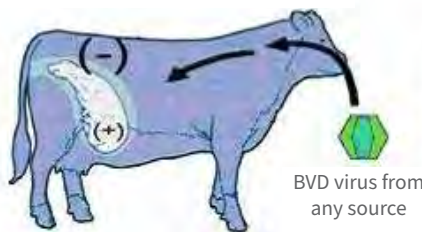

Less common route
(Less than 10%)

BVDV persistently infected (PI) female becomes pregnant

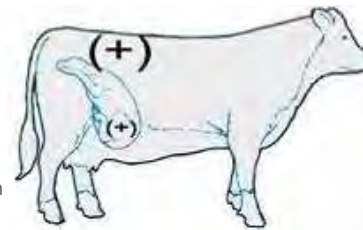

BVDV persistently infected (PI) calf is produced



PI calf

**Loneragan; Journal of the American Veterinary Medical Association, 2005*

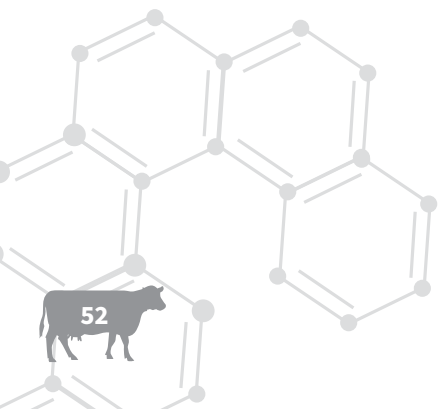

Disease Diagnostics (cont.)

Bovine viral diarrhea is one of the most costly pathogenic viruses in the dairy world, and early identification of persistent infection cases is key to preserving the integrity of your herd's health. It is widely observed that BVDV-PI cattle are not only more likely to become chronically ill or die than non-BVDV-PI cattle, but they are able to shed virus to other animals and bred cows are able to vertically infect a fetus[†].

BVD diagnostic testing can be done as a standalone service, or as an add-on to any sample submitted for the Igenity Dairy Heifer Program. If an animal tests positive for BVD-PI, the sample will not continue on for genomic testing. This ensures that you are only paying for genomic profiles on animals most likely to become superior females. GeneSeek's laboratory is ISO 17025 accredited by the American Association on Laboratory Accreditation.

Johne's: \$4.50

Johne's disease can be controlled and even eliminated from infected herds, however, it takes a thorough understanding of the disease by animal owners, consultation with a veterinarian, and requires use of one or more of the available diagnostic tests. Half-hearted attempts to control Johne's disease will generally fail. Control of Johne's disease also takes time and a strong commitment to management practices focused on keeping young animals away from contaminated manure, milk, water, etc. A typical herd clean up program may take 5 years or longer[†].

The basics of control are simple: new infections must be prevented, and animals with the infection must be identified and removed from the herd.

Johne's Disease: Only the Tip of the Iceberg is Showing

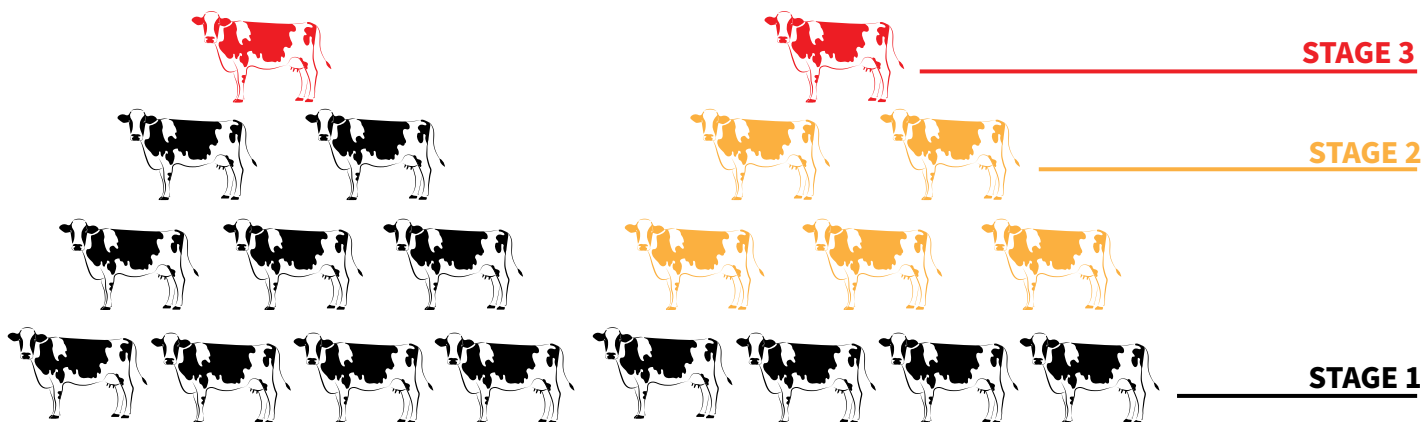

Johne's Disease Stage 3

Clinically Infected animals often suffer from weight loss, decreased production and are suffering from symptoms of Johne's Disease.

Johne's Disease Stage 2

Subclinical animals often show no symptoms, but are actively shedding MAP (*Mycobacterium avium* ss. *Paratuberculosis*).

Johne's Disease Stage 1

Animals show no clinical symptoms and are not shedding MAP. Typically young stock.

[†]Citation: University of Wisconsin, School of Veterinary Medicine

Calf Care

A Calf Bottle with Teat

Nursing bottle holds 2 liters / 1/2 gallon / 4 pints, and comes with pint calibration markings. Bottle is made from strong, durable polyethylene. An X-pierced, self-closing, red rubber teat is included. These snap-on type nipples are strong, soft, and pliable, with a tight fit to help prevent leakage.

Item No.	Description	Case Ct.
FW1216-SYR	Calf Bottle w/Red Teat 2L	12
FW1216A-SYR	Red Rubber Calf Teat	50
FW1222-SYR	Calf Bottle Premium Pink Teat Snap-On	12
FW1222A-SYR	Premium Pink Teat Snap-On	50
7008	Screw-On Calf Bottle 64 oz.	12



B Calf Weaners

These anti-sucking devices impede calves' ability to suck. Durable and easy to apply.

Item No.	Description	Case Ct.
TA913	Weaner Calf Plastic Yellow	50
TA916	Weaner Calf Plastic Orange	50
TA918	Weaner Calf Plastic Orange 50/pk	10



C Oral Fluid Feeders

Safe and practical way to fluid feed calves with a one piece flexible probe to deliver nutrients directly to the stomach. Recommended method for rehydration of stressed cattle.

Item No.	Description	Case Ct.
TA20006	Oral Fluid Feeder 64oz	1
TA20009	Oral Fluid Feeder 128oz	1



D Small Water Bowl

Small PVC plastic drinking bowl equipped with 1/2" brass nipple and valve system. Has a flow valve and nylon frost plug protection. The nose paddle is easily activated by small animals. Ideal for sheep, goats, calves and dogs.

Item No.	Description	Case Ct.
FW1229	Small Plastic Water Bowl with Valve	2



E Calf Blankets

- 600 denier outer shell
- 250 gram fill insulation
- 2 inch wide leg & belly straps
- Machine washable
- Adjustable criss-cross belly straps

Item No.	Description	Case Ct.
BL30-92240	Calf Warming Blanket 24" L	6
BL30-92280	Calf Warming Blanket 28" XL	6



F Bottle Holders

Bottle holder to hang on side of calf structure.

Code	Description	Count	Case
4999-1110-039	Coated, 15in. L X 4.75in. W X 6.5in. H 2qt holder	1	6

F



G Calf Bottle and Nipple Brush

A special brush designed especially for cleaning calf bottles and nipples. One end for cleaning the bottle, the other for cleaning the nipple. Nylon bristles on a wire handle.

Code	Description	Count	Case
4999-1150-054	Calf Bottle and Nipple Brush	1	12

G



H Calf Bottle Brush

Soft polyester bristles are wound with stainless steel wire. All plastic handle with knurled grip.

Code	Description	Count	Case
4999-1150-053	Calf Bottle Brush	1	12

H



I Bradon Dry Feed Bottle

Convenient top-loading Bradon dry feed bottle is suitable for any type of grain or starter mix, with the exception of high syrup content feeds. Lets the calf feed with little spillage. One nipple will last for 2-3 calves.

Code	Description	Count	Case
4999-1110-068	Bradon Dry Feed w/Nipple, Complete	1	20
4999-1110-069	Dry Feed Replacement Nipple	1	25

I



J Crown Weaning Ring

Simple construction and practical design, this crown style weaning ring is made of aluminum and stainless steel and is rust and corrosion proof.

Code	Description	Count	Case
4999-1110-435	Calf Size Weaning Ring	1	1
4999-1110-436	Cow Size Weaning Ring	1	1

J



K Calf Pail

Made from polyethylene resin that is impact resistant and protects against cracks and warping. Features a heavy-duty wire bail.

Code	Description	Count	Case
4999-1110-073	Calf 7.6 L/8 qt Blue	1	24
4999-1110-074	Calf 7.6 L/8 qt Green	1	24
4999-1110-075	Calf 7.6 L/8 qt Red	1	24

K



Calf Care (cont.)



Pail Holders

Constructed of 0.25 in. heavy gauge black epoxy coated wire. Two designs to hook over a 2 in. thick board or wire panel. Fits pail up to 9.25 in. or pail size up to 10 qts.

Code	Description	Count	Case
4999-1110-078	Calf Double for Boards	1	12
4999-1110-079	Calf Double for Wire Panel	1	24
4999-1110-080	Calf Single for Boards	1	24
4999-1110-081	Calf Single for Wire Panel	1	24



Plastic Calf Pail

Tough impact resistant, high density polyethylene plastic with a strong galvanized handle. Holds shape when full without wobble or flex. Both sizes come in assorted colors (black, yellow and red). The 4qt is 7.5in. H x 7.5in. ID, with handle diameter 0.1in. and is sold by packs of 24. The 10qt is 9in. H x 9.5in. ID, with handle diameter 0.16in. and is sold in packs of 12.

Code	Description	Count	Case
4999-1110-213	Plastic Calf Pail 10 qt Red (pk/12)	12	1
4999-1110-233	Plastic Calf Pail 10 qt grad. Black (pk/12)	12	1



Oral Treatments & Drenching

Neogen's Ideal® Animal Health brand offers a wide range of oral supplements for dairy market and calf ranch segment. Neogen's high quality nutritional additives, therapeutic treatments and recovery supplements provide you with the solutions to promote optimum animal health that is effective and economical.

A Kaolin Pectin

Anti-diarrheal Solution

Kaolin Pectin is for oral administration as an aid in the treatment of non-infectious diarrhea in horses, cattle, dogs and cats.

Item No.	Description	Case Ct.
79219	Kaolin Pectin 1 gal	4
79220	Kaolin Pectin 32 oz	12

A



B Milk of Magnesia

Antacid

For the relief of gastric reflux, sour stomach, acid indigestion, and mild constipation in dogs and horses.

Item No.	Description	Case Ct.
79135	Milk of Magnesia 1 gal	4

B



C Propylene Glycol, USP

Ketosis Preventive

Propylene Glycol, USP is for use as an aid in prevention and treatment of Ketosis (acetonemia) in cattle.

Item No.	Description	Case Ct.
79231	Propylene Glycol USP 1 gal	4

C



D Stress-Dex®

Oral Electrolyte Powder

Stress-Dex is an oral electrolyte powder used as a supplemental source of calcium, phosphorus, salt and potassium with a palatable orange flavor.

Item No.	Description	Case Ct.
79174	Stress-Dex 4 lb	4
79176	Stress-Dex 12 lb	2
79177	Stress-Dex 20 lb	2

D



E Metal Balling Guns

Sturdy balling guns feature metal fabrication to resist corrosion for long, trouble-free service. The heads are reinforced for extra strength to resist breakage.

Item No.	Description
4000	Balling Gun 16" Farmer's Steel Head - 1" diameter w/clips
4002	Balling Gun 16 3/4" Farmer's Plastic Head - 7/8" diameter w/clips

E

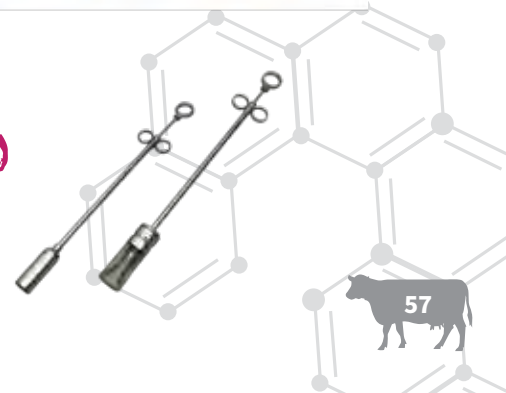

Oral Treatments & Drenching (cont.)

F Plastic Balling Guns

Corrosion resistant, light weight plastic balling guns for the cost conscious producer.

Item No.	Description
4015	Balling Gun Plastic M
4016	Balling Gun Plastic S



G Multi-Bolus Balling Gun

The Multi-Bolus Balling Gun was designed for delivery of up to six boluses. The trigger action dispenses one bolus with each squeeze of the handle. Multiple bolus doses are delivered quickly and easily with little stress to the animal and operator. Administers six 240-gram capsules and is 17 1/2" long.

Item No.	Description
4013	Multi-Bolus Balling Gun 17.5"



H Rumen Magnets

Rumen magnets attract metal objects in the rumen to help prevent hardware disease. Powerful 3" rectangular magnets are 1/2" in diameter. Ringed ferrite rumen magnets are 3/4" in diameter by 2 3/4" long.

Item No.	Description	Case Ct.
TA133	Rumen Magnet Ringed Ferrite Each	12
9803	Rumen Magnet Ringed Ferrite 3 pk	4
9804	Rumen Magnet Ceramic 3 pk	4
TA145	Rumen Magnet Ceramic Nylon Coated Each	12
TA2503	Rumen Magnet Stainless Steel 3 pk	4
TA2504	Rumen Magnet Stainless Steel Each	12



I Stomach Pump and Tube

This efficient, light weight stomach pump is solidly constructed of highly-polished, nickel-plated brass. It contains ball valves for efficient suction and has a tapered hose connection that fits most stomach tubes. The stomach tube should be passed with a speculum.

Item No.	Description
8000	Stomach Pump 125 mL
8761	Stomach Tube, Koroseal, 10' tube (7/8" OD, 3/8" ID)



J Speculum

Frick's style speculum is 18 5/8" and is for use with the Stomach Pump Set.

Item No.	Description
8700	Speculum Frick's Style 19 5/8"

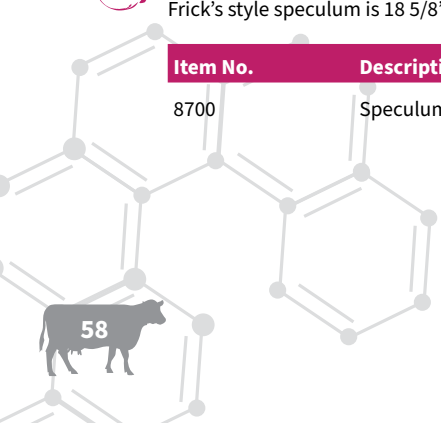

K Drench Syringes

Automatic drenchers are built to precise standards and suitable for many drenching applications where accuracy and speed are needed. The guns have extremely rapid fill time and the dial-a-dose selection allows changes from large to small doses without any product wastage. Accessories include angled, hooked, and floating hook nozzles.

Item No.	Description	Case Ct.
345103	70mL w/6.6" Angled Drench	12
346568	70mL w/23" Floating Hook	12
346926	Prima 70 mL w/Hook Drench	12
365903	80mL w/Nozzle	12
365934	80mL w/Floating Hook	12
365743	80mL w/Long Angled Tip	12
HA070	70cc w/Nozzle	1
HA006	200cc w/Nozzle	1
HA300	300cc w/Nozzle	1



L Animal Aspirin

Aspirin boluses are used in reducing fever as well as minor joint aches and muscular pains. Each bolus contains 240gm of aspirin. Dosage for cattle is 2 to 4 boluses, and calves 1 to 2 boluses. No milk or slaughter withholding (2.13lb). **Approved for U.S. only.**

Code	Category	Description	Count	Case
08897	Care Product	Animal Aspirin Bolus 240 g	50	4



M Cal-Gel

Cal-Gel is a specially formulated mineral supplement for use in dairy cows. Helps maintain normal calcium levels during stressful prepartum and postpartum periods and prevent lung aspiration. A Swedish study has demonstrated that the reoccurrence of milk fever can be lowered by 50% with the oral dosing of a calcium chloride gel. Each 300mL cartridge, one dose, contains 53g of calcium plus magnesium chloride and cobalt sulfate. No milk or slaughter withholding. Not recommended for cows showing severe milk fever symptoms. **Approved for U.S. only.**

Code	Category	Description	Count	Case
4999-1182-040	Care Product	Cal-Gel 447 g 300 mL Cartridge	1	12



N Keto-Nia-Fresh

An all-natural source of energy for fresh cows and heifers. Aids in helping to maintain normal blood glucose levels and help stimulate feed intake. Ideal for use when first signs of ketosis appear. Give one tube following calving and repeat as needed. **Approved for U.S. only.**

Code	Category	Description	Count	Case
4999-1182-001	Care Product	Keto-Nia Fresh 300 mL Tube	1	12



Needles & Syringes



Ideal® D3™ Detectable Needles

Durable. Detectable. Dependable.

Durability

Superior durability; thick wall cannula and plated brass hubs reduce breakage 6-fold over conventional needles

Detectability

- 100% detectable in metal detection systems vs. only 15% for standard needles

Sharpness

- Precision-ground tip stays sharper longer, allowing for multiple injections without burring

Packaging Features

- Gauge stamped on hub and packed in red cartridges and boxes for easy identification
- Cartridges are tamper-evident and labeled with needle size and lot number

Item No.	Description	Color
9415	D3 16Gx5/8" Detectable HP 100/bx	Red
9416	D3 16Gx3/4" Detectable HP 100/bx	Red
9420	D3 16Gx1" Detectable HP 100/bx	Red
9417	D3 16Gx1.5" Detectable HP 100/bx	Red
9428	D3 18Gx1/2" Detectable HP 100/bx	Red
9422	D3 18Gx5/8" Detectable HP 100/bx	Red
9421	D3 18Gx3/4" Detectable HP 100/bx	Red
9423	D3 18Gx1" Detectable HP 100/bx	Red
9424	D3 18Gx1.5" Detectable HP 100/bx	Red
9418AL	D3 AH 14Gx1" Detectable HP 100/bx	Red
9419AL	D3 AH 14Gx1.5" Detectable HP 100/bx	Red

Tri-beveled tips

Stainless steel
detectable cannula

Brass hub

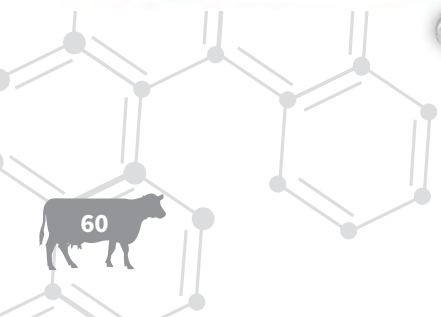

B Aluminum Hub Needles

Aluminum hub for large animal applications that require a durable needle.

Item No.	Description	Gauge Color
9400AL	AH 14Gx1" HP 100/bx	Green
9401AL	AH 14Gx1.5" HP 100/bx	Green
9402AL	AH 14Gx2" HP 100/bx	Green
9403AL	AH 16Gx5/8" HP 100/bx	White
9404AL	AH 16Gx3/4" HP 100/bx	White
9405AL	AH 16Gx1" HP 100/bx	White
9406AL	AH 16Gx1.5" HP 100/bx	White
9407AL	AH 18Gx5/8" HP 100/bx	Pink
9408AL	AH 18Gx3/4" HP 100/bx	Pink
9409AL	AH 18Gx1" HP 100/bx	Pink
9410AL	AH 18Gx1.5" HP 100/bx	Pink

B



ISO Needle Gauge Color Code Chart

Green	White	Pink
14 G	16 G	18 G

Neogen's line of syringes offers a broad spectrum of solutions to the animal health industry. From disposable syringes used in one time settings, to durable syringes built to last in the most rigorous animal production environments, Neogen has a variety of syringes available for any job.



Needles & Syringes (cont.)

Ideal's disposable syringes are made specifically for the animal health industry. The syringes and combos are offered in Premium Hard Packs and Standard Soft Pack packaging. Ideal syringes feature a clear polypropylene barrel and large easy to read graduations to help minimize dosing errors. The combos offer ultra-sharp needles and are ISO color coded to indicate gauge for easy identification.



Premium (Hard Packed) Disposable Syringes

Premium Syringe Features

- Latex-free
- Clear polypropylene barrel for easy viewing of fluid levels
- Large, easy-to-read graduations
- Positive plunger stop allows for maximum filling and eliminates costly spills
- Serrated thumb press for positive grip

Premium Needle Features

- Ultra-sharp, tri-beveled, anti-coring tips
- Metal inserts to increase strength for animal health applications

Premium Packaging Features

- Hard pack design for veterinary office or field use
- ISO color-coded cartridge caps for easy gauge identification
- Sonic-welded end cap provides tamper-evident seal and ensures sterility
- Product information sticker on box and case box for easy inventory control

Item No.	Needle Gauge / Length	Style
1 cc Tuberculin Syringes (Box of 100; case of 10 boxes)		
8859	25Gx5/8"	Luer Slip
3 cc Syringes (Box of 100; case of 10 boxes)		
8875	Syringe Only	Luer Lock
8861	Syringe Only	Luer Slip
6 cc Syringes (Box of 50; case of 10 boxes)		
8882	Syringe Only	Luer Lock
8881	Syringe Only	Luer Slip
12 cc Syringes (Box of 80; case of 6 boxes)		
8886	18Gx1"	Luer Lock
8884	18Gx1"	Luer Slip
8885	Syringe Only	Luer Lock
8883	Syringe Only	Luer Slip
20 cc Syringes (Box of 50; case of 6 boxes)		
8890	Syringe Only	Luer Lock
8889	Syringe Only	Luer Slip
35 cc Syringes (Box of 30; case of 6 boxes)		
8892	Syringe Only	Luer Lock
8891	Syringe Only	Luer Slip
60 cc Syringes (Box of 20; case of 6 boxes)		
8894	Syringe Only	Luer Lock
8893	Syringe Only	Luer Slip





Standard (Soft Packed) Disposable Syringes

Standard Syringe Features

- Clear polypropylene barrel for easy viewing of fluid levels
- Large, easy-to-read graduations
- Positive plunger stop allows for maximum filling and eliminates costly spills
- Medical grade silicone lubricant inside barrel for smooth, accurate delivery
- Serrated thumb press for positive grip

Standard Needle Features

- Ultra-sharp, tri-beveled, anti-coring tips
- Translucent ISO color-coded hubs for easy viewing of flashback and quick gauge identification in or out of the packaging
- Anti-friction coating for minimal penetration resistance and animal discomfort

Standard Packaging Features

- Paper-to-plastic packaging is tamper-evident and ensures sterility
- Product information sticker on box and case box for easy inventory control
- Each syringe/combo has UPC, lot number, manufacture and expiration date printed on package

Item No.	Description	
1 cc Syringe (Box of 100; case of 24 boxes)		
9178	Syringe Only	Luer Slip
3 cc Syringes (Box of 100; case of 24 boxes)		
9170	Syringe Only	Luer Lock
9100	Syringe Only	
6 cc Syringes (Box of 100; case of 24 boxes)		
9171	Syringe Only	Luer Lock
9110	Syringe Only	Luer Slip
12 cc Syringes (Box of 100; case of 12 boxes)		
9287	18Gx1"	Luer Lock
9250	18Gx1"	Luer Slip
9172	Syringe Only	Luer Lock
9120	Syringe Only	Luer Slip
20 cc Syringes (Box of 50; case of 6 boxes)		
9173	Syringe Only	Luer Lock
9130	Syringe Only	Luer Slip
35 cc Syringes (Box of 50; case of 6 boxes)		
9174	Syringe Only	Luer Lock
9140	Syringe Only	Luer Slip
60 cc Syringes (Box of 25; case of 8 boxes)		
9175	Syringe Only	Luer Lock
9150	Syringe Only	Luer Slip



Needles & Syringes (cont.)

Neogen's extensive line of durable syringes includes the Prima line that has been trusted by industry professionals for many years.

E

Nylon Syringes

Durable nylon syringes are designed for one-hand operation, and are easy to disassemble and clean. The syringes have a luer lock fitting and accept oral drench pipes.

Item No.	Description	Case Ct.
9810	10cc Blue w/ Dosing Nut	12
9812	20cc Red w/ Dosing Nut	12
9813	30cc Yellow w/ Dosing Nut and Drench Pipe	12
9814	30cc Green w/ Dosing Nut	12
9816	50cc Yellow w/ Dosing Nut	12

E



F

MegaShot™

Ideal's MegaShot pistol-grip syringe repetitively injects doses of 1 to 5 cc quickly and easily without sacrificing accuracy, as its rear dosage dial locks securely to ensure a precise dose. The frame and plunger disassemble easily for cleaning and sterilization. MegaShot features a rubber plunger and virtually indestructible Lexan barrel. Comes with an Ideal NeedleGuard®.

Item No.	Description	Case Ct.
1000	MegaShot Syringe 50cc	12

Replacement parts for MegaShot Syringe - Luer lock adapter washer, packings and end washers.

F



Item No.	Description	Figure No.
9762	LL washer packings end washers	6, 7, 8
9717	Rear main frame handle spring and handle connecting screw	11, 12, 13
9741	PL Barrel/ EW / Packings Spreader Washer LL Washer	6, 7, 8, 14, 16
9706	Thumb Rest Inner Rod Packings and Ratchet Sleeve	3, 4, 5, 7
9714	Luer Lock Adapter	1, 6
9716	Front Trigger Handle, Handle Connecting Screw	10, 12
9758	Dog Trigger, Dog Trigger Screw and Inner Spring	9
9759	Thumb Rest and handle spring	5, 11

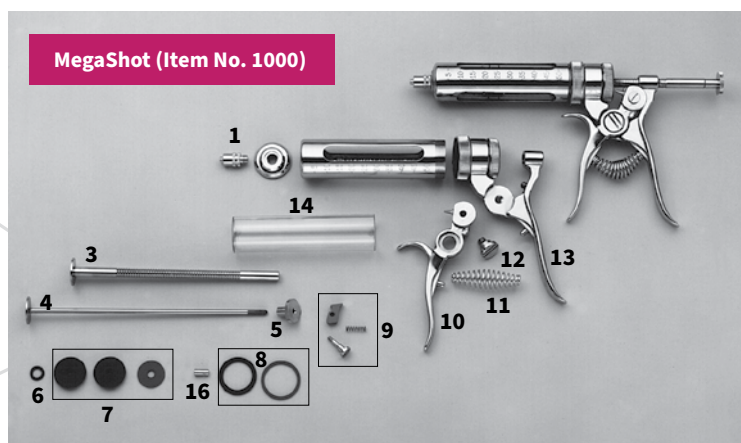

MegaShot (Item No. 1000)



Prima-Shot™

The Prima-Shot™ 50 mL repeater syringe adjusts from 0.5 mL to 5 mL in 0.5 mL increments, and features an easy to grip dose adjuster dial to make dosing changes easy. Features a heavy duty Tritan™ Barrel that is BPA-free, highly chemical and scratch-resistant, and has chemical compatibility that surpasses both polycarbonate and polypropylene.

- 10 fixed dose settings ranging from 0.5 - 5 mL
- Durable rugged construction for repetitive use
- Ergonomic design is easy on hands
- Triton barrel for superior chemical compatibility
- Large numbers on barrel that are easy to read
- Amber-colored barrel for UV Protection

Item No.	Description	Case Ct.
367723	Prima-Shot Syringe 50 mL	12
377210	Prima-Shot Syringe 25 mL	12

Replacement parts

Item No.	Description
374172	Barrel with O-Ring Prima-Shot
374196	Replacement O-Ring 12 pk
374158	Pull Knob Inserts Multi-Color 4 pk



Pro-Shot™

Ideal's Pro-Shot pistol-grip syringe was engineered for the cost-conscious producer who doesn't want to sacrifice accuracy for price. Pro-Shot is built from light-weight high-impact plastic. Its transparent barrel is made of nonporous polypropylene, which will not discolor. Its simple dosage sleeve can be easily adjusted from 1 to 5 cc. This syringe has a non-adjustable nylon plunger assembly and a luer lock hub. The accurate 50 cc Pro-Shot syringe combines the features of Ideal's time-tested pistol-grip syringes, yet is economically priced. Replacement O-ring included.

Item No.	Description	Case Ct.
1008	Pro-Shot Syringe 50cc	12



Pro-Shot™ II

Ideal's Pro-Shot II 50 cc pistol-grip syringe is ruggedly built from high-impact aluminum to be both durable and light-weight. Its simple dosage sleeve can be easily adjusted from 1 to 5 cc. This syringe has a non-adjustable nylon plunger assembly and a luer lock hub. The extremely accurate Pro-Shot II combines the outstanding features of Ideal's time-tested pistol-grip syringes, yet is economically priced. Replacement O-ring included.

Item No.	Description	Case Ct.
1009	Pro-Shot II Syringe 50 cc	12



Prima® Injectors

This versatile Prima Injector dials from 1 mL to 12.5 mL in .5 mL increments. It has an ultra-durable design with an elongated needle nut for extra application protection. Available with polycarbonate or polypropylene barrels for compatibility across all compounds.

Item No.	Description	Case Ct.
214102	12.5mL Adj. Injector Premium Polycarbonate Barrel	12
358844	12.5mL Adj. Injector Premium Polypropylene Barrel	12
336569	12.5mL Adj. Injector Premium 5" Drench Nozzle	12
343499	12.5mL Adj. Injector Value	32
375124	12.5mL Adj. Injector with Hook Drench Nozzle	12
206251	Barrel w/ O-ring for 12.5mL Injector	12



Needles & Syringes (cont.)



Prima® BMV Syringes

The Prima Bottle Mount Vaccinator is designed to allow for efficient and effective application of all animal health injectables. The self-contained, one-handed unit allows for full mobility and automatic refilling of syringes without returning to the bottle. The line feed convertible barrels allow you to change from a bottle mount to a line feed vaccinator.

Item No.	Description	Case Ct.
341129	1 mL Fixed Premium	12
206558	2 mL Adj Premium	12
206657	5/6 mL Adj Premium	12
348159	2 mL Adj Premium w/Line Feed Convertible Barrel	12
348364	5 mL Adj Premium w/Line Feed Convertible Barrel	12
356352	1 mL Adj Value	32
344724	1 mL Fixed Value	32
344762	2 mL Adj Value	32
361004	2 mL Fixed Value	32
343444	5/6 mL Adj Value	32
344779	Barrel w/O-Ring Adj 1 mL BMV	12
206800	Barrel w/O-Ring Adj 2 mL BMV	12
206855	Barrel w/O-Ring Adj 5 mL BMV	12
346506	Barrel w/O-Ring Fixed 2 mL BMV	12



Premium

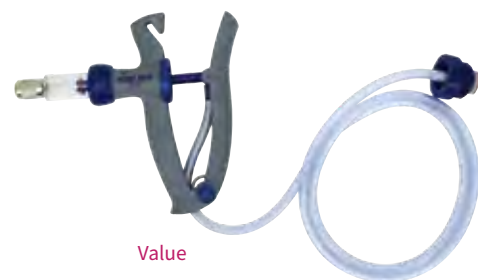

Value



Prima® Vaccinators

The Prima Vaccinator has a rugged construction and an advanced design, making it more comfortable to use. The syringe has an ergonomically designed handle to better fit the contour of your hand. The large dosage adjuster on the adjustable syringes makes changing dosages effortless.

Item No.	Description	Case Ct.
349491	1 mL Adj Premium	12
351722	1 mL Fixed Premium	12
205803	2 mL Adj Premium	12
351012	2 mL Fixed Premium	12
206008	5 mL/6 mL Adj Premium	12
351739	1 mL Adj Value	32
359704	1 mL Adj Value w/ Draw-Off Caps	32
351746	1 mL Fixed Value	32
366191	2 mL Fixed Value	32
212757	2 mL Adj Value	32
359711	2 mL Adj Value w/ Draw-Off Caps	32
213655	5/6 mL Adj Value	32
359728	5/6 mL Adj Value w/ Draw-Off Caps	32
353306	Barrel w/O-Ring Adj 1 mL Vaccinator	12
353351	Barrel w/O-Ring Fixed 1 mL Vaccinator	12
206404	Barrel w/O-Ring Adj 2 mL for Vaccinator	12
353351	Barrel w/O-Ring fixed 2 mL for Vaccinator	12
217400	Barrel w/O-Ring Adj 5 mL/6 mL for Vaccinator	12



Premium



Value

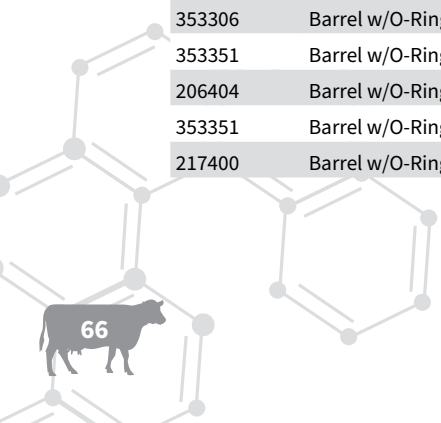

Drenchers

M Drench Syringes

Automatic drenchers are built to precise standards and suitable for many drenching applications where accuracy and speed are needed. The guns have extremely rapid fill time and the dial-a-dose selection allows changes from large to small doses without any product wastage. Accessories include angled, hooked, and floating hook nozzles.

Item No.	Description	Case Ct.
345103	70 mL w/6.6" Angled Drench	12
346568	70 mL w/23" Floating Hook	12
346926	Prima® 70 mL w/ Hook Drench	12
365903	80 mL w/Nozzle	12
365934	80 mL w/Floating Hook	12
365743	80 mL w/Long Angled Tip	12
HA070	70 cc w/Nozzle	1
HA006	200 cc w/Nozzle	1
HA300	300 cc w/Nozzle	1



345103

Pour-On Guns

N Prima® Pour-Ons

Prima Pour-On guns allow for adjustable dosage increments with an accurate and easy to use dial-a-dose system. The guns have a shower head nozzle which avoids wastage from splashing, the nozzles are angled for easy administration of pour on medication, a T-bar applicator is also available. Guns are packed with soft medical grade tubing, hose armor springs, and nozzle.

Item No.	Description	Case Ct.
330901	30 mL Adj w/8 mm Hose Barb	12
351098	30 mL Adj w/12 mm Hose Barb	12
352910	30 mL Adj w/8 mm Barb/Tbar/Plastic Nozzle	12
201058	50 mL Adj w/ P Barrel & soft tubing	12
332585	70 mL Adj w/ P barrel & soft tubing	12
346797	70 mL Adj w/ Header Card	12
351630	80 mL Adj w/Tritan™ Barrel & soft tubing	12
353627	Barrel 30 mL Pour-On Applicator	12
346179	Barrel 70 mL Pour-On Applicator	12



201058

330901

352910

351630

Accessories

O Prima® Mist Sprayer

The Prima Mist sprayer is a versatile addition to our Prima line of syringes. The mist produced from the sprayer has implications of use ranging from intranasal vaccines, to topical application of medicines and anesthetics. The sprayer fits all Prima syringes, it is not suggested for use with syringes over 2 mL or the BMV Fast fit system.

Item No.	Description	Case Ct.
353597	Prima Mist Sprayer	12
364876	Prima Mist Replacement Foam Tip	12



Needles & Syringes (cont.)

P Sterimatic Needle Guards

The Sterimatic safety kit fits easily on to any Prima Syringe and offers unparalleled protection from deadly self-injection, the transmission of disease causing agents (including PRRS and E.coli) and accidental needle pricks. Able to be used with or without sterilizing SteriCaps[®], which are safe to use with live or modified live vaccines.

Item No.	Description	Case Ct.
357021	Needle Guard Sterimatic ½" w/2 Stericaps w/o Needles Clear	12
357038	Needle Guard Sterimatic 1" w/2 Stericaps w/o Needles Green	12
358929	Sterimatic Caps (12/bag)	12

P



Q Needle Nut

For use with Prima Syringes.

Item No.	Description	Case Ct.
330840	Needle Nut Luer Lock Metal	12
334671	Needle Nut Replacement Metal 12.5mL Injector	12

Q



R Vac-Pacs

Insulated bottle holders.

The Hip-Hugger uses a belt that straps around the waist.

The On-Arm straps to the upper arm with two comfortable Velcro straps that are extremely durable.

The Hanging version has a heavy Velcro strap that can be used to hang the unit on cattle chutes, processing carts, etc.

Item No.	Description	Case Ct.
120007	On-Arm L 500-1000mL	12
120052	On-Arm M 250mL	12
120151	Hanging L 500-1000mL	12
120205	Hanging M 250mL	12
120304	Hip Hugger L 500-1000mL	12
120359	Hip Hugger M 250mL	12

R



On-Arm

Hanging

Hip-Hugger

S Prima[®] Bottle Collars

Standard bottle collars. For use with Prima Syringes.

Item No.	Description	Case Ct.
218902	Bottle Collar, Small 125mL/20mm Necks	12
332080	Bottle Collar, Medium 250mL/30mm Necks	12
339980	Bottle Collar, Large 250mL/33mm Necks	12
336699	Bottle Collar Threaded 28mm	12
349262	Unilock System w/Draw-Off Spike/20, 30, 33mm Collar & Tube	12

S

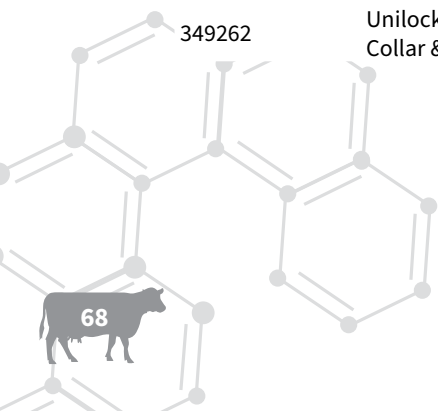



Prima® Draw-Offs

For use with tube-fed syringes. Various sizes to fit all bottle types.

Item No.	Description	Case Ct.
141859	Draw-Off 20mm Small w/o Tubing	12
141804	Draw-Off 30mm Large w/o Tubing	12
220356	Draw-Off 33mm X-Large w/o Tubing	12
343567	Draw-Off Vented for Backpacks for Pour-On Tubing	1



Tubing

Soft PUC tubing

Item No.	Description	Case Ct.
126054	Tubing 4'	12



Prima® Fast-Fit

Bottle holder for 100 and 250 mL bottles. For use with Prima BMV Syringes. (Page 42)

Item No.	Description	Case Ct.
336811	Fast-Fit 100/125mL/20mm	12
342713	Fast-Fit 250mL/30mm	12
342720	Fast-Fit 250mL/33mm	12



Prima® Spike Accessories

For use with Prima BMV Syringes, the filtrating spike is over 99% effective in filtering debris from bottles.

Item No.	Description	Case Ct.
366153	Filtrating Spike	12
366382	Filtrating Spike Kit	12
340795	Spike Removal Tool	1
340931	Spike Buffer Seal BMV	12



Prima® Drench Syringe Accessories

For use with Prima drench syringes.

Item No.	Description	Case Ct.
345110	Floating Hook and Adapter 23"x8" for Pour-On	12
342737	Hooked Drench 8.6"x5.9"	12
333025	Nozzle Drench 3" Metal w/Metal Nut	12
332882	Nozzle Drench 4.75" Metal w/Metal Nut	12
334602	Nozzle Drench 5" Metal w/Metal Nut	12

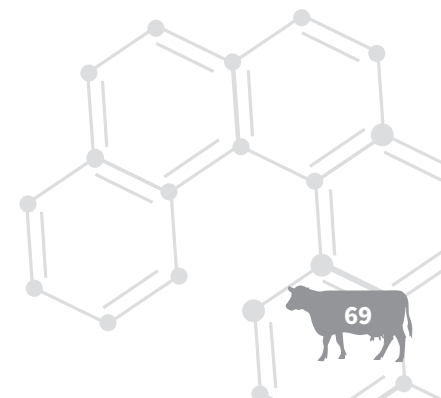

Needles & Syringes (cont.)



Prima® Pour-On Accessories

For use with Prima Pour-on guns to evenly distribute liquids.

Item No.	Description	Case Ct.
352507	Nozzle Modular, T-BAR	12
365927	Fan Tip Kit	12



Prima® Back Packs

Back packs have a hard plastic construction with vented cap to prevent vacuum from forming, for use with Prima Syringes.

Item No.	Description	Case Ct.
341662	1 L w/Transit Cap/Stepped Cap/Hang Strap	1
341679	2.5 L w/Transit Cap/Stepped Cap/Hang Strap	1
341686	5 L w/Transit Cap/Stepped Cap/Hang Strap	1



Prima® Lubricating Oil

This food grade manufacturing hydraulic oil is an anti-wear lubricant. Lubricates syringe o-rings.

Item No.	Description	Case Ct.
338013	Lubrication Oil Food Grade 2 oz	12



Prima® O-Rings

Silicone replacement O-rings for Prima Syringes.

Item No.	Description	Case Ct.
351272	0.3 mL	12
349712	0.5 mL	12
358769	1 mL	12
203304	2 mL	12
203502	5-6 mL	12
206305	12.5 mL	12
374172	50 mL Prima-Shot	12



IV Sets

The Dexco IV set is one of the easiest to use and most durable intravenous systems ever designed. Its pure gum rubber funnel with air vent fits any standard 500 mL bottle, and comes with stainless steel needle. The Dexco IV set is also available with latex tubing. Tubing measures 5'. The Simplex IV set has a molded finger, clog-stop air vent, and pure gum rubber tubing. It fits any standard 500 mL bottle, and comes complete with a stainless steel needle. Tubing measures 5'.

Code	Description	Case Ct.
1905	IV Set Dexco w/Gum Rubber Tubing 16G x 1½"	12
1906	IV Set Simplex w/Gum Rubber Tubing 16G x ½"	12
1907	IV Set Dexco w/Latex Tubing 16G x 1½"	12
TA8145	IV Set Simplex w/14G x 2"	1

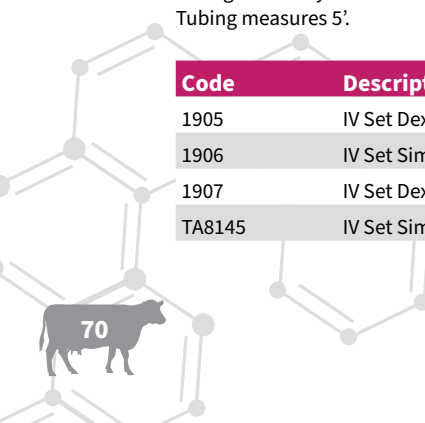

Wound & Surgical Supplies

A AluShield™ *Aerosol Bandage*

AluShield is a unique aerosol bandage that protects wounds from dirt, debris, bacteria and insects, while still allowing the wound to breathe. AluShield is for use on horses, sheep and cattle. Contains aluminum powder, 40%.

Item No.	Description	Case Ct.
79100C	AluShield 75 g Can	12

B Blood Stop Powder *Coagulant for Minor Cuts*

Blood Stop Powder is for use as an aid in control of capillary bleeding from minor cuts and wounds in horses, cattle and sheep. May also be used on dogs and cats when clipping nails or claws.

Item No.	Description	Case Ct.
79204	Blood Stop Powder 16 oz	12

C Drawing Salve *Grooming Aid*

Drawing Salve is for use on hooves, nails and skin of horses and dogs.

Item No.	Description	Case Ct.
79105	Drawing Salve 14 oz	12

D Gentle Iodine Wound Spray *Topical Antiseptic*

Gentle Iodine Wound Spray is a topical antiseptic of 1% titratable iodine for use on horses, cattle and swine. May be used prior to surgical procedures such as castrating and tail docking, for application to the umbilical stump (navel) of newborn animals, and for minor cuts, teat sores, bruises and abrasions.

Item No.	Description	Case Ct.
79214	Gentle Iodine Wound Spray 1% 16 oz	12
79215	Gentle Iodine Wound Spray 1% 1 gal	4

E Scarlet Oil *Wound Dressing*

Scarlet Oil is used to treat simple wounds, cuts and abrasions on livestock.

Item No.	Description	Case Ct.
79239	Scarlet Oil 16 oz	12



Wound & Surgical Supplies (cont.)

F Topical Fungicide

Benzalkonium Chloride

Topical Fungicide is a topical antiseptic for use on cattle, sheep and goats as an aid in the control of foot rot. May be used on horses, dogs and cats as an aid in the control of girth itch (ringworm) and other fungal skin problems. May also provide soothing relief for summer itch (sweet itch).

Item No.	Description	Case Ct.
79209	Topical Fungicide 16 oz	12

G Elastic Adhesive Tape

Stretches easily and conforms to any shape without restriction of movement. Porous, allows skin to breathe. Tearable. Center marking line for ease of evenly overlapping tape. Sold by box only.

Item No.	Description
TA3102E	Elastic Adhesive Tape 2" 6/bx

H Gauze

Individually wrapped rolls of 6 ply gauze. Sterile.

Item No.	Description	Case Ct.
TA4144	Gauze 6 Ply 3.4"x3.6yd 1/roll	96

F



G



H



Did you know?

From simple scratches and lacerations to deep abscesses and surgical incisions, wounds are inevitable with animals. Providing timely and proper wound care is essential for quick recovery. Neogen provides a complete line of wound care products for animals for easy and proper wound maintenance. Neogen's products include topical antiseptics, FDA approved antibacterial ointments, coagulants and aluminum spray bandages.

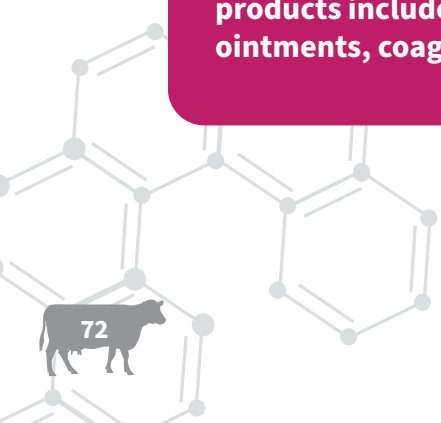

**Hoof Wrap**

Economical cohesive bandage for bovine applications. Sold by box only.
See more options for cohesive bandages in Hoof Care.

Item No.	Description
TA3400HW-HP	SyrFlex Hoof Wrap 4" Hot Pink 100/bx
TA3400HW-O	SyrFlex Hoof Wrap 4" Orange Hot Pink 100/bx
TA3400HW-R	SyrFlex Hoof Wrap 4" Red Hot Pink 100/bx

**Infusion Pump**

Small black rubber bulb-type infusion pump. 12" tubing with removable stopper.

Item No.	Description	Case Ct.
1908	Infusion Pump Bulb Type	12

**Trocar**

Relieves pressure and bloating in cattle; cannula remains when trocar is removed, allowing gas to escape. Wooden handle with plain cannula.

Item No.	Description	Case Ct.
8703	Trocar Wooden Handle w/Plain Cannula	6

**Chromic Suture**

Sterile. Single-use catgut sutures. Absorbable.

Item No.	Description	Case Ct.
ZA003M	Suture Chromic 2/0 w/needle 3/pk	4

**DA Toggle Suture**

Toggle suture for surgery on displaced abomasum.

Code	Category	Description	Count	Case
4999-1110-859	Sutures	DA Toggle Suture (PK/2)	2	10

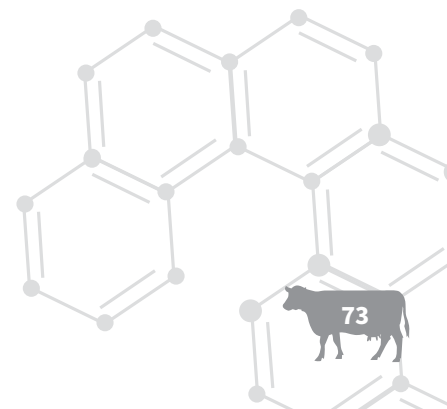

Castration & Dehorning

Neogen's line of castration and dehorning instruments are designed to help producers and veterinarians handle animals safely and easily. We offer a variety of castration tools for your preferred method with everything from elastrators and bands, to bloodless castrators and emasculators. We also offer scalpel blades and handles in our castration kits for those who prefer surgical castration methods.

A **Castrator Bands**
Latex Castrating Bands - pack of 100

Item No.	Description	Case Ct.
2007	Castrating Bands 100pk	25

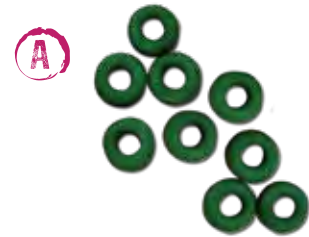

B **Economy Band Castrator**
Ideal's durable Economy Band Castrator was designed for the cost-conscious producer.

Item No.	Description	Case Ct.
2008	Band Castrating Pliers Plastic	12
TA131	Band Castrating Pliers Metal	12



C **Premium Band Castrator**
This easy-to-use instrument was designed for the one-person operation of castrating lambs, calves, goats and other animals quickly and easily. It may also be used for docking and prolapses.

Item No.	Description	Case Ct.
2005	Premium Band Castrating Pliers	12

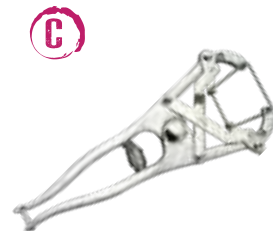

D **Electric Tail Docker**
A useful tool that cuts and cauterizes at the same time to help prevent tail biting problems. The heated blade instantly cauterizes the wound, minimizing bleeding and infection. The tripod design allows tool to stay upright while heating and between dockings. Can also be used for severing umbilical cords. 110 volts.

Item No.	Description	Case Ct.
TA992	Electric Tail Dock 110V	6

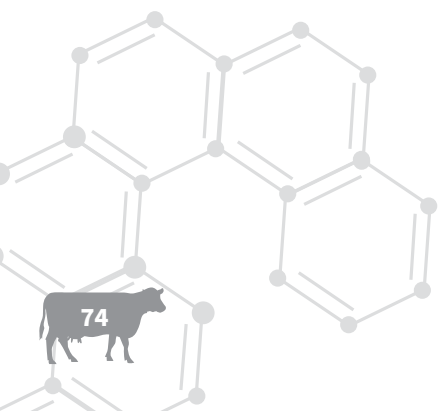



Electric Calf Dehorner

Cast bronze electric dehorner with a 5/8" inner diameter. Preferred for dehorning small calves and goats. It only requires a few seconds and there is no blood loss using this dehorner.

Item No.	Description	Case Ct.
2103	Sheep & Goat Electric Dehorner 5/8"	6



WARNING: This product can expose you to the chemicals including lead, which is known to the State of California to cause cancer and birth defects or other reproductive harm. For more information go to www.P65Warnings.ca.gov.



Dr. Naylor Dehorning Paste

Quick, safe, and economical. Single application is all that is needed for young calves, lambs or kids.

Item No.	Description	Case Ct.
DHP	Dehorning Paste 4 oz (Naylor)	12



Hoof Care

Hoof care is essential and Neogen provides a wide variety of quality hoof care tools and products to keep your cattle, horses, swine, sheep or goats moving soundly. Whether you are a professional hoof trimmer, farrier, producer or hobby farmer you can find what you need in Neogen's hoof and leg care product line-up. This includes trusted brand names such as Easy Bloc, Demotec 95, SureBond, SyrFlex and Burgon & Ball — all known for their quality in every sense of the word.



Demotec® Easy Bloc®

Easy Bloc is a unique innovation in hoof treatment. Hoof problems can have very adverse effects on both milk yields and weight gain. The Easy Bloc system was designed to minimize lameness and provide a fast, easy to use "cure" at a reasonable cost. Incorporating features of similar devices, and a patented off-set toe, Easy Bloc is a plastic slip-on boot which fits onto the healthy claw, taking weight off the affected claw, providing immediate relief of pain and substantial increase in milk production. Easy Bloc was designed by leading hoof-care specialists from around the world and has unique features not available with other hoof blocking systems. Easy Bloc is available in kits of 4, 12, or 36 applications and in standard and extra-long lengths. Sets in approximately 5 minutes.

- Easy to use, even by inexperienced personnel
- Fits nearly all size cows
- Optimum design avoids all possible pressure points
- Mix the resin in the block itself, then press onto the claw
- Flexible cover ensures a good fit
- Affordable price

Item No.	Description
EB100-L	Easy Bloc Left Boot 1ct
EB100-R	Easy Bloc Right Boot 1ct
EB100XL-L	Easy Bloc XL Left Boot 1ct
EB100XL-R	Easy Bloc XL Right Boot 1ct
EB112	Easy Bloc 12 Kit (ORM-D)
EB112-L	Easy Bloc 12 Kit All Lefts (ORM-D)
EB112-R	Easy Bloc 12 Kit All Rights (ORM-D)
EB112-XL	Easy Bloc XL 12 Kit (ORM-D)
EB112XL-L	Easy Bloc XL 12 Kit All Lefts (ORM-D)
EB112XL-R	Easy Bloc XL 12 Kit All Rights (ORM-D)
EB136	Easy Bloc 36 Kit (ORM-D)
EB136-L	Easy Bloc 36 Kit All Lefts (ORM-D)
EB136-R	Easy Bloc 36 Kit All Rights (ORM-D)
EB136-XL	Easy Bloc XL 36 Kit ((ORM-D)
EB136-XL-L	Easy Bloc XL 36 Kit All Lefts (ORM-D)
EB136-XL-R	Easy Bloc XL 36 Kit All Rights (ORM-D)
EB250	Easy Bloc Liquid 250mL (ORM-D)
EB500	Easy Bloc Powder 500g (ORM-D)

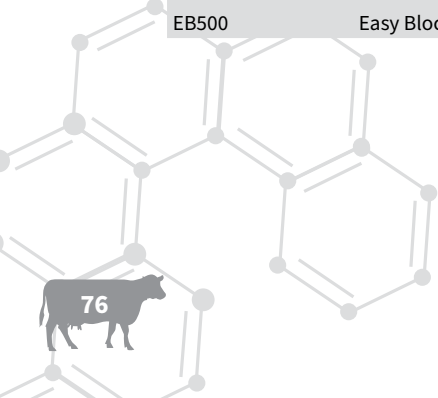

B**Demotec® 95**

Demotec 95 is a special resin developed for treatment of lameness in cattle. This resin material has superior plasticity without being sticky and can be processed only a few seconds after mixing. Bonding a wooden block onto the good claw of a bovine hoof relieves pain and reduces lameness. The wooden blocks are available in two lengths and come in kits of 2 or 14 applications. Items can also be purchased separately. Demotec 95 resin can also be used by veterinarians, horse owners and farriers for repairing numerous other hoof problems and for splintering pet fractures.

Item No.	Description
HC080	Demotec 95 Liquid 80mL (ORM-D)
HC100	Demotec 95 Powder 1kg (ORM-D)
HC202-L	Demotec 95 2/Kit w/ L Blocks (ORM-D)
HC214-L	Demotec 95 14/Kit w/ L Blocks (ORM-D)
HC214-S	Demotec 95 14/Kit w/ S Blocks (ORM-D)
HC500	Demotec 95 Liquid 500mL (ORM-D)

B**C****FuturaPad®**

FuturaPad is packaged in a complete pack; no extra components are needed. Available in two sizes: standard and XL.

- Fast, easy and safe
- Activate the pad, press the block onto the claw and you're done!
- Polymerization within 15 seconds, even during cold weather
- Shaped to conform to the anatomy of the claw
- The flexible pad overcomes any unevenness of the sole
- No health, transport or storage problems

Item No.	Description
FP110	FuturaPad 5 pair (ORM-D)

C**D****SureBond®**

Neogen's SureBond product is a fast-setting urethane adhesive designed for use in applying wooden or rubber blocks as an adjunct in the treatment of bovine lameness. SureBond is available in 210mL tubes.

Item No.	Description	Case Ct.
SB47540	SureBond Hoof Adhesive 210mL	12
SBT012	Mixing Tips, 12/ bag	100
SBT100	Mixing Tips, 100/ bag	15
TA4158	Adhesive Dispensing Gun	1

D**E****PrimaBond®**

PrimaBond is the next generation in two-part fast curing urethane adhesive for hoof care. Quickly and easily apply wood or rubber blocks as an adjunct treatment for bovine lameness. PrimaBond comes in 200mL tubes that are easy-to-handle and are resealable. The mixing tip uniformly mixes the two parts, displaying as green in color, producing a fast curing, non-brittle bond.

Item No.	Description	Case Ct.
SB2012	Fast-Set Adhesive - 200 mL	12
SBT012	Mixing Tips, 12/ bag	100
SBT100	Mixing Tips, 100/ bag	15
TA4158	Adhesive Applicator Gun	1

E

Hoof Care (cont.)

F

Hoof Blocks

Designed for use as an aid in the treatment of bovine lameness, Neogen's wooden blocks are applied with an adhesive to the healthy claw, transferring weight off the affected claw. Wooden blocks are made of hard birch wood providing superior wear and come in two sizes, small and large. Rubber blocks are available in large. Both styles sold in eaches; 100/case.

Item No.	Description	Case Ct.
HC400-L	Hoof Block Wood L 1ct	100
HC400-S	Hoof Block Wood S 1ct	100
RB100	Hoof Block Rubber 1ct	100

F



G

Hoof Knives

Ideal's hoof knives, made with contoured, polished steel blades and hardwood handles, are designed to provide maximum leverage and pressure.

Item No.	Description	Case Ct.
9805	Hoof Knife Right Hand	6
9806	Hoof Knife Double Sided	6
9807	Hoof Knife Left Hand	6
TA146	Hoof Tester Pliers	12
TA2650	Hoof Rasp w/Handle	6

G



H

Aesculap Hoof Knives

Made of high-grade stainless steel blades that maintain a sharper edge.

Item No.	Description	Case Ct.
TA2604	Hoof Knife Narrow Blade Right Hand	12
TA2605	Hoof Knife Narrow Blade Left Hand	12
VC300	Hoof Knife Narrow Blade Right Hand	1
VC302	Hoof Knife Wide Blade Right Hand	1
VC305	Hoof Knife Narrow Blade Left Hand	1
VC307	Hoof Knife Wide Blade Left Hand	1
VC310	Hoof Knife Narrow Blade Right Hand Black	1
VC311	Hoof Knife Narrow Blade Left Hand Black	1
VC315	Hoof Knife Narrow Blade Double Edge	1
VC316	Hoof Knife Standard Blade Double Edge	1
VC317	Hoof Knife Wide Blade Double Edge	1
VC320	Hoof Knife Thin Ground Blade Right Hand	1
VC321	Hoof Knife Thin Ground Blade Left Hand	1
VC376	Hoof Tester Vienna Pattern	1

H

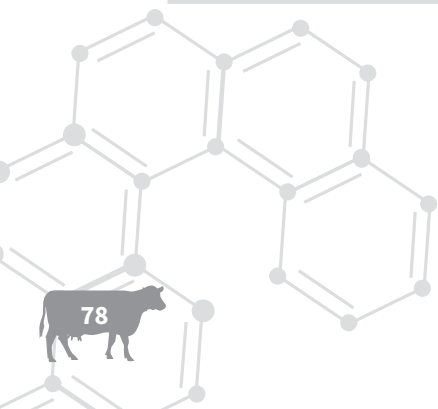



Demotec® Claw Check

Designed to provide objective measurements for the claw trimming process, the Claw Check is an easy-to-use device that serves five functions: measure the angle between the sole and the anterior claw wall, the length of the anterior wall, the height of the two claws, the plane of contact of the sole to ground and the slope of the sole.

Item No.	Description
CC100	Hoof Claw Check



B&B Eze-Trim Foot Rot Shears

These super-sharp foot rot shears are made by Burgon & Ball and have non-stick coated, high carbon-steel blades that retain the sharpest edge. Blades have been heat treated to give the optimum combination of strength and hardness. The blade tension can be adjusted and the blades lock in place. Resin handles are both durable and extremely comfortable to use. Shears come with a 5-year manufacturer's guarantee.

Item No.	Description	Case Ct.
7020	Foot Rot Shear B&B Eze Trim	10



Hoof Rot Shears

Ideal Hoof Rot Shears have sharp, pointed double stainless steel blades. The top blade is serrated to cut hooves with ease. Blue powder coated handle. Use to trim cattle, sheep and goat hooves.

Item No.	Description	Case Ct.
9801	Hoof Rot Shears	12



Trimming Discs

Manufactured in Germany of high grade aluminum, the Trimming Disc is lightweight, yet durable. The Trimming Disc is ideal for situations where a less aggressive, easy to handle disc is preferred. Fits most standard hand-held grinders.

- Trims up to 220 head (880 hooves) per disc
- Lightweight aluminum construction allows for easier control
- Blades are manufactured of tungsten carbide and are double-sided for extended use
- Unique wheel design allows for gentle hoof cutting without smells, dust or heat
- Reduces trimming time at a very low cost per animal

Item No.	Description	Case Ct.
TD100	Hoof Trimming Disc	1
TD060	Hoof Trimming Disc Blades 6pk	1

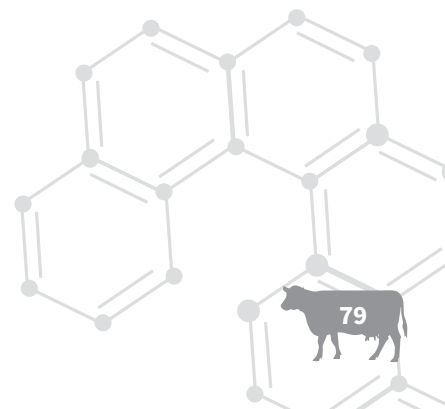

Hoof Care (cont.)



SyrFlex 4" Cohesive Bandages

Self-adhesive, maintains original shape and size, offers Starting Line Technology for ease of unrolling. Provides consistent lightweight compression; does not tighten with wear. 8 pound tensile strength. Individually wrapped. Sold in eaches. 18/box

Item No.	Description	Case Ct.
TA3400BL-E	SyrFlex Bandage 4" Blue 18/bx	108
TA3400BLK-E	SyrFlex Bandage 4" Black 18/bx	108
TA3400GRN-E	SyrFlex Bandage 4" Green 18/bx	108
TA3400HP-E	SyrFlex Bandage 4" Hot Pink 18/bx	108
TA3400NAT-E	SyrFlex Bandage 4" Natural 18/bx	108
TA3400OR-E	SyrFlex Bandage 4" Orange 18/bx	108
TA3400PUR-E	SyrFlex Bandage 4" Purple 18/bx	108
TA3400RED-E	SyrFlex Bandage 4" Red 18/bx	108
TA3400WH-E	SyrFlex Bandage 4" White 18/bx	108
TA3400YEL-E	SyrFlex Bandage 4" Yellow 18/bx	108
TA3400CP*	SyrFlex Bandage 4" Color Pack 18/bx	108

*Sold by box only



Hoof Wrap

Economical cohesive bandage for bovine applications. Sold by box only.

Item No.	Description
TA3400HW-HP	SyrFlex Hoof Wrap 4" Hot Pink 100/bx
TA3400HW-O	SyrFlex Hoof Wrap 4" Orange Hot Pink 100/bx
TA3400HW-R	SyrFlex Hoof Wrap 4" Red Hot Pink 100/bx



Foot Bath

Made from high density polyethylene with poly textured bottom. Thick walled, one-piece construction is seamless, with self-supporting frame. Cannot be shipped UPS.

Code	Description	Count	Case
4999-1112-121	Polythylene 6.5ft x 2.5ft x 6in.	1	1



E-Z Copper

E-Z Copper aids in the prevention and treatment of hairy wart and foot rot. E-Z Copper is formulated to energize footbath solutions and reduce the use of copper sulfate crystals. Reduce the hassles of heavy bags with the ease of liquid E-Z Copper. Its ionized copper helps condition feet and hoof material, yet it is mild and non-damaging to surrounding skin tissue. Read and follow all label recommendations prior to use. Initial application use 1-gallon E-Z Copper with 20 lbs copper sulfate with 50 gallons of water.

Code	Description	Count	Case
4999-1110-553	Hoof Treatment E-Z Copper 5gal	1	1

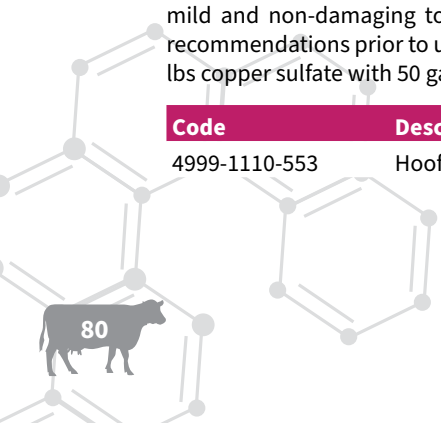



QuickHit Concentrate

QuickHit concentrate is formulated to be an aid in the treatment of hairy warts (Papillomatous Digital Dermatitis) in dairy cattle. QuickHit is a highly concentrated product developed specifically for treatment of existing warts. For dairymen who have a high incidence of warts in their herds and need to rapidly get the problem under control. Contains both copper and zinc, adding health benefits not found in other competitive products. Use QuickHit as a direct topical spray on the hairy wart. Clean the hoof and use full strength. Spray to the point of runoff twice a day. Continue to spray for four or five days. Severe hairy wart cases may be wrapped with cotton or gauze soaked with QuickHit. After treatment follow a prevention program using Healthy Foot and E-Z Copper. **Special formulation required in Canada, see product listing below.**



Code	Description	Count	Case
4999-1110-530	QuickHit 32 oz US	1	6
4999-1110-531	QuickHit 1 gal US	1	4
4999-1187-098	QuickHit 3.8 L (x4) Canada	4	1



Sure Stop Plus

Hoof bath liquid additive solution enhanced with copper sulfate.

Code	Description
680011	SURE STOP PLUS is a hoof bath liquid additive with extra acidity and copper sulfate.



Handling & Identification

Animals should always be handled in a calm, controlled and gentle manner. Electric prods should be used judiciously and only in extreme circumstances when all other techniques have failed. Electrical devices should never be applied to sensitive parts of the animal such as the face, genitalia, or mucous membranes.

Always use electric prods in accordance with Dairy Quality Assurance™ standards

For more information visit: bqa.org/programs/dairy-bqa

A

Jolt® Value 100

JOLT's Value 100 is a great prod for an economical price with the latest motor technology. It's lightweight and has an ergonomic grip for comfort and ease of use. Works under both wet and dry conditions. The Value 100 includes a 1-year electronic warranty.

Item No.	Description	Case Ct.
6932	Jolt Value 100 Stock Prod Unit	6

⚠️ WARNING: This product can expose you to the chemicals including lead, which is known to the State of California to cause cancer and birth defects or other reproductive harm. For more information go to www.P65Warnings.ca.gov.

A



B

Jolt® High Performance 200

JOLT's High Performance 200 has a rugged design for commercial use with a high efficiency motor, and comes with a button clip. Patented one-piece molded handle provides durability and moisture resistance. An optional rechargeable battery pack and charger are available. The High Performance 200 includes a 2-year electronic warranty.

Item No.	Description	Case Ct.
6933	JOLT Stock Prod HP 200 Handle Unit	6

⚠️ WARNING: This product can expose you to the chemicals including lead, which is known to the State of California to cause cancer and birth defects or other reproductive harm. For more information go to www.P65Warnings.ca.gov.

B



C

Jolt® High Performance 250 Rechargeable

JOLT's High Performance 250 comes with a high-powered and longer-lasting rechargeable battery and a button clip. Patented one-piece molded handle provides durability and moisture resistance. This unit has a rugged design for commercial use and a high efficiency motor. An advanced electronic charger is included along with a 2-year electronic warranty.

Item No.	Description	Case Ct.
6934	Jolt High Performance 250 Rechargeable Handle Unit	6

⚠️ WARNING: This product can expose you to the chemicals including lead, which is known to the State of California to cause cancer and birth defects or other reproductive harm. For more information go to www.P65Warnings.ca.gov.

C

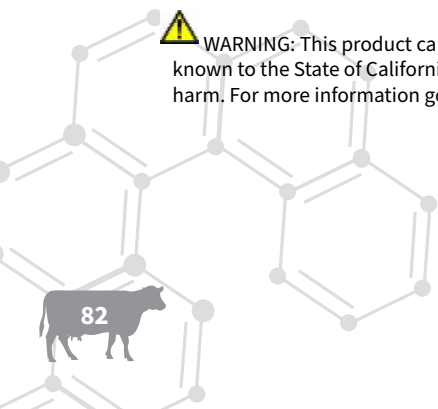



Jolt® Electric Stock Prod Shafts

Jolt Electric Stock Prod Shafts are available in five lengths. For use with Jolt prod handle units.

Item No.	Description	Case Ct.
6936	JOLT Stock Prod Shaft 32"	6
6937	JOLT Stock Prod Shaft 36"	6
6938	JOLT Stock Prod Shaft 42"	6
6939	JOLT Stock Prod Shaft 52"	6



WARNING: This product can expose you to the chemicals including lead, which is known to the State of California to cause cancer and birth defects or other reproductive harm. For more information go to www.P65Warnings.ca.gov.



Jolt® Electric Stock Prod Accessories

Replacement parts for High Performance 200 and 250 model units.

Item No.	Description
6942	JOLT Stock Prod Replacement Motor
9772	JOLT Stock Prod Rechargeable Battery Pack
9773	JOLT Stock Prod Rechargeable Battery Pack with Charger
6940	JOLT Stock Prod AC Charger



WARNING: This product can expose you to the chemicals including lead, which is known to the State of California to cause cancer and birth defects or other reproductive harm. For more information go to www.P65Warnings.ca.gov.



Bull Leads

Place lead into the animal's nostrils and close gently. Secure handles with the 13 1/2" nickel-plated metal chain. Lead animal by the chain or handles.

Item No.	Description	Case Ct.
7000	Bull Lead w/o Chain	12
7001	Bull Lead w/Chain	12



Bull Ring

Ideal's 3" brass bull ring is self-piercing and durable. A long, sharp piercing point ensures a clean cut. Locks in place with a break-off screw.

Item No.	Description	Case Ct.
7002	Bull Ring 3"	12



Cow Lift

For cows that cannot stand up on their own, such as right after giving birth. The gummed clamps are adjustable to the cow's size. The lift is placed over the cow's hips and tightened as necessary by cranking the handle, which secures the cow as she is lifted. This enables the cow to regain the use of her legs so she can be milked or treated.

Item No.	Description
TA1800	Cow Lift - up to 2,000lbs / 900kg
TA1805	Cow Lift - up to 3,300lbs / 1,500kg



Handling & ID (cont.)

I Cow Hobbles

Cow hobble prevents kicking and is also used to keep animals stable after difficult calving or in slippery conditions.

Ref. 1 - Strong light weight unique one-piece design features easy on/off velcro straps. Secure comfortable, washable, and easy to put on. Very strong 21in. x 1.5in. with nickel plated hardware.

Ref. 2 - Same design as regular split guard, except it is 2in. wide. Longer spread allows cows to walk freely while wearing the unit. Features twin locking nickel-plated hardware and easy on and off adjustable velcro hook and loop securing leg straps.

Ref. 3 - Adjustable from 12in. to 21in. Made of 6000# tensile strength webbing with stainless steel rings and post-lock buckles.

Code	Category	Description	Count	Case
4999-1110-453	Leg Band	Split Guard Regular Strap Gold	1	1
4999-1110-454	Leg Band	Split Guard Heavy Duty Green	1	1
4999-1110-456	Leg Band	Cow Cufflink II Red	1	1
TA2037	Leg Band	Cow Hobble Adj.	1	1

I



4999-1110-453



4999-1110-454



4999-1110-456



TA2037

Being able to quickly and easily identify livestock is essential for livestock producers. Neogen provides a wide array of solutions for both permanent and non-permanent identification. Permanent livestock identification solutions include plastic ear tags and tattoo kits with a wide variety of accessories. For temporary identification to mark animals for treatment, breeding, calving and lambing, etc. we offer reusable plastic and Velcro leg bands, marking sticks, livestock marking paints and dyes.

J Ear Tag Applicator

The deep jaw of this applicator makes proper tag placement easier. Grip helps to ease hand fatigue. Comes with two black inserts to accommodate different styles of ear tags.

Item No.	Description	Case Ct.
SA	Ear Tag Applicator Universal	1

J



K Plastic Ear Tags

Our ear tags are made of high quality polymer for longlife and high visibility. They are laser printable or can be written on with a plastic Tag Marker.

Item No.	Description	Case Ct.
ETAG M BL SET	Ear Tag Set Medium Blue 25/pk	40
ETAG M YEL SET	Ear Tag Set Medium Yellow 25/pk	40
ETAG XL BL SET	Ear Tag Set XL Blue 25/pk	40
ETAG XL WH SET	Ear Tag Set XL White 25/pk	40
ETAG XL YEL SET	Ear Tag Set XL Yellow 25/pk	40

K





Plastic Tag Marker

Plastic tag markers are fast drying and non-smearing with a permanent weather-resistant black ink. The broad tip marker is self-inking with valve action.

Item No.	Description	Case Ct.
TA3502-B	Broad Tip Plastic Tag Marker 12/bx	4



Allflex Electronic Identification

The HDX Ultra EID Tag is tamperproof which provides security and retention. The HDX technology optimizes signal transmission and provides greatest possible read distance. HDX technology is beneficial for use in packing plants, automated reading systems, or with a walk through reads. The HDX reusable EID Tag can be used to lower the per animal cost of EID. Both are ISO compliant.

Code	Category	Description	Count	Case
4999-1036-346	Ear Responder	Alfl HDX982 Reusable EID tag	20	1
4999-1036-351	Ear Tag	Male Button w/Reusable HDX	20	12



Allflex Tags

Maxi Ear Tag - All sold in sets of 25 tags and studs.

Tag size: 4in. H x 3in. W. Number size: 1.75in. H. Popular uses: beef and dairy. Our most popular size because numbers are highly visible.

Code	Category	Description	Count	Case
4999-1036-200	Ear Tag	Alfl Maxi Orange Blank	25	1
4999-1036-201	Ear Tag	Alfl Maxi Yellow Blank	25	1
4999-1036-202	Ear Tag	Alfl Maxi White Blank	25	1
4999-1036-214	Ear Tag	Alfl Maxi Specify Color & Number	25	1
4999-1036-311	Ear Tag	Alfl Maxi Green Blank	25	1



Large Ear Tag - All sold in sets of 25 tags and studs.

Tag size: 3in. H x 2.25in. W. Number size: 1.125 in. H. Popular uses: calves and feedlot cattle.

Code	Category	Description	Count	Case
4999-1036-234	Ear Tag	Alfl Lg Green Blank	25	1
4999-1036-235	Ear Tag	Alfl Lg Orange Blank	25	1
4999-1036-236	Ear Tag	Alfl Lg Yellow Blank	25	1
4999-1036-237	Ear Tag	Alfl Lg White Blank	25	1
4999-1036-249	Ear Tag	Alfl Lg Specify Color & Number	25	1



Medium Ear Tag - All sold in sets of 25 tags and studs.

Tag size: 2in. H x 1.625in. W. Number size: 0.75in. H. Popular uses: ewes, calves and hogs where chewing is not a problem.

Code	Category	Description	Count	Case
4999-1036-284	Ear Tag	Alfl Md Specify Color & Number	25	1



Handling & ID (cont.)

0 Z-Tag

Z's revolutionary design and the reason for its growing popularity are as easy to see as the tags themselves. Unmatched tag retention. Guaranteed to stay in longer than any other ear tag system. The neck of the tag is flexible to give if it catches on wire or bush. It simply slides off rather than breaking or pulling out of the ear like other brands. Superior readability non-fade numbers. A special hot-stamp printing process etches numbers deep into the tag panel for long-term legibility. The one-piece design makes it fast and simple to use. The built-in cutting tip makes a small incision that heals quickly and snugly around the tag. Easier to put in. No more torn ears. No other tag is so easy to load or apply. Slip the one-piece tag over the pin, hold the applicator over the ear, squeeze and the tag is in to stay. If the animal jerks away the tag goes in. The pin swivels out in the direction of the movement.

Accessories (1)

Code	Category	Description	Count	Case
4999-1034-998	Applicator	Z-Tag Applicator	1	
4999-1035-000	Ear Tag	Z-Tag Calf Yellow Blank	25	1
4999-1034-999	Felt-tip Marker	Z-Tag Felt Tip Marker	1	

Z-Tag Calf (2)

Code	Category	Description	Count	Case
4999-1035-009	Ear Tag	Z-Tag Calf Yellow Specify Number	25	1
4999-1035-020	Ear Tag	Z-Tag Calf Orange Blank	25	1
4999-1035-029	Ear Tag	Z-Tag Calf Orange Specify Number	25	1
4999-1035-060	Ear Tag	Z-Tag Calf White Blank	25	1
4999-1035-069	Ear Tag	Z-Tag Calf White Specify Number	25	1
4999-1035-270	Ear Tag	Z Calf Numbered Both Side Specify	25	1
4999-1035-280	Ear Tag	Z 2 Male Calf Specify Color & Number	25	1

Z-Tag Cow (3)

Code	Category	Description	Count	Case
4999-1035-140	Ear Tag	Z-Tag Cow Yellow Blank	25	1
4999-1035-149	Ear Tag	Z-Tag Cow Yellow Specify Number	25	1
4999-1035-160	Ear Tag	Z-Tag Cow Orange Blank	25	1
4999-1035-169	Ear Tag	Z-Tag Cow Orange Specify Number	25	1
4999-1035-200	Ear Tag	Z-Tag Cow White Blank	25	1
4999-1035-209	Ear Tag	Z-Tag Cow White Specify Number	25	1
4999-1035-271	Ear Tag	Z Cow Numbered Both Side Specify	25	1
4999-1035-429	Ear Tag	Z 2 Piece Cow Specify Color & Numbered	25	1

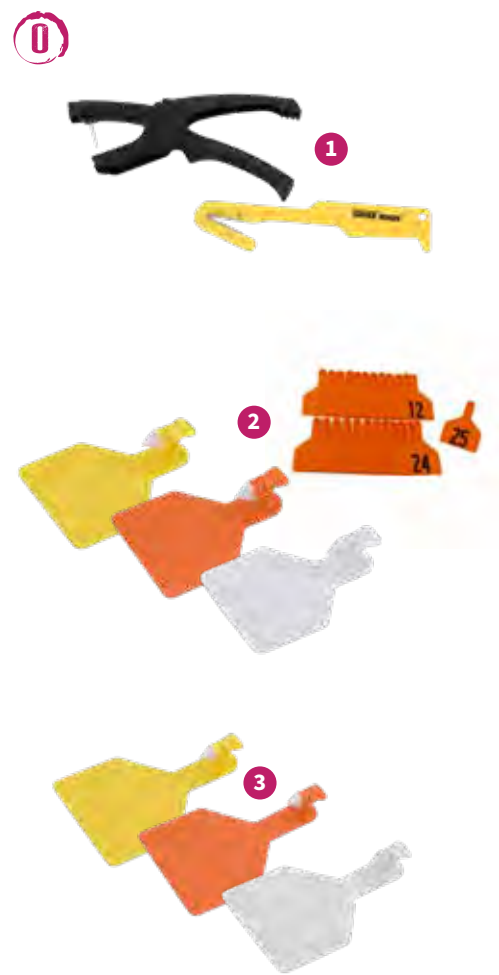

P Plastic Leg Bands

Reusable, tough leg bands for marking cows in a group pen. The bands have a ratchet lock for easy adjustment on different size ankles. Available in several colors for flexibility in herd identification. Use to indicate a temporary condition such as mastitis, or to number animals individually. Easy to attach and easy to remove and reuse. Sold in eaches.

Item No.	Description	Case Ct.
TA1515	Leg Band Blank White	100
TA1516	Leg Band Blank Pink	100
TA1519	Leg Band Blank Orange	100
TA1522	Leg Band Blank Red	100
TA1525	Leg Band Blank Blue	100
TA1528	Leg Band Blank Green	100
TA1531	Leg Band Blank Yellow	100

P



Q Multi-Loc Leg Band

When attached to a dairy cow's rear leg, Multi-Loc bands provide a conspicuous way of identifying cows. They are used to give the milkers information about an animal, such as treated, dry, or any color coded/ number plan for livestock identification. It is easy to install and can be taken off and reused. Made of flexible plastic formulation that is not affected by hot or cold weather. Multi-Loc bands are 1.5in. wide and 13.5in. long. Available in six colors. All letters/numbers are black except white on red bands.

Code	Category	Description	Count	Case
4999-1022-057	Leg Band	Multi-Loc Yellow Caution!	1	10
4999-1022-059	Leg Band	Multi-Loc Red Caution!	1	10
4999-1022-063	Leg Band	Multi-Loc Yellow Dry!	1	10
4999-1022-065	Leg Band	Multi-Loc Red Dry!	1	10
4999-1022-071	Leg Band	Multi-Loc Red Treated!	1	10

Q



R Tattoo Kits

Ideal Tattoo Kits are versatile, economical instruments with heavy-duty construction used for permanent animal identification. The large pliers hold four 3/8" letters or digits. The small pliers hold five 5/16" digits. Aluminum alloy pliers.

Item No.	Description	Case Ct.
7502	Tattoo Kit Standard 3/8" Complete	6
7503	Tattoo Digits (0-9) 3/8"	6
7504	Tattoo Digits (0-9) 5/16"	6
7510	Tattoo Kit Small 5/16"	12
7530	Tattoo Letters (A-Z) 3/8"	12
7531	Tattoo Letters (A-Z) 5/16"	12
7577	Tattoo Ink Black 3oz	12
7578	Tattoo Paste Green 1oz	12
7590	Tattoo Ink Green 2oz Roll-on	12

R



Handling & ID (cont.)

S

Push-Up Livestock Markers

Livestock Markers are highly visible, fade resistant and long-lasting, standing up to all types of weather. They will mark wet or dry animals and come in a sturdy push-up style dispenser.

Item No.	Description	Case Ct.
LMBL-E	Push-Up Livestock Marker Blue Each	12
LMFLPK-E	Push-Up Livestock Marker Fluorescent Pink Each	12
LMGRN-E	Push-Up Livestock Marker Green Each	12
LMORG-E	Push-Up Livestock Marker Orange Each	12
LMRED-E	Push-Up Livestock Marker Red Each	12
LMYEL-E	Push-Up Livestock Marker Yellow Each	12

S



T

Retractable Marking Sticks

Designed for easy and efficient animal marking, these markers come in a twistable plastic dispenser with cap to help keep hands and clothing clean. Highly visible, long lasting, and weather and fade resistant. Will mark wet or dry animals. Non-toxic.

Item No.	Description	Case Ct.
333643	Prima Retractable Marking Stick Black	50
333650	Prima Retractable Marking Stick Orange	50
333667	Prima Retractable Marking Stick Red	50
333674	Prima Retractable Marking Stick Green	50
333681	Prima Retractable Marking Stick Blue	50
333704	Prima Retractable Marking Stick Purple	50
333711	Prima Retractable Marking Stick Fluorescent Pink	50

T



U

Spray-On

- Colors are durable and stable
- Reliable in all temperatures
- Strong color
- Sprays with can inverted

Item No.	Description	Case Ct.
333513	Spray-On Red 12 oz	12
333520	Spray-On Blue 12 oz	12
333537	Spray-On Green 12 oz	12
338747	Spray-On Black 13 oz	12

U



V

Spray-On Glo

- Colors are durable and stable
- Reliable in all temperatures
- Strong color with high luminosity
- Sprays with can inverted
- 13 oz cans

Item No.	Description	Case Ct.
338693	Spray-On Glo Fluorescent Green	12
338389	Spray-On Glo Fluorescent Orange	12
339690	Spray-On Glo Fluorescent Purple	12
339942	Spray-On Glo Fluorescent Pink	12
339959	Spray-On Glo Fluorescent Yellow	12

V



W

Spray-On II

- Longer lasting than regular Spray-On
- Reliable in all temperatures
- Strong color
- Sprays with can inverted
- 12 oz cans

Item No.	Description	Case Ct.
354228	Spray-On II Red	12
354235	Spray-On II Blue	12
354242	Spray-On II Green	12

W



X

Tail Tie

Cow tail ties are used to keep cows cleaner when tied in a stanchion barn for winter. Made of elastic cord with a safety split ring.

Code	Category	Description	Count	Case
4999-1110-500	Tail Holder	Elastic Cord & Split Ring	1	

X



Y

Neck Chain

Top quality neck chain 40in. long. Packed 50/box.

Code	Category	Description	Count	Case
4999-1022-017	Chain	Neck Bright 40 in.	1	50

Y

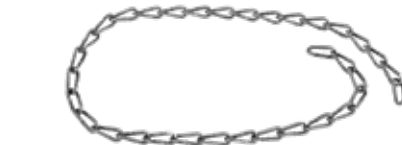

Z

Ring Fastener

Rings are used with both steel and plastic chain. Inside diameter 1.25 in. For safety, the ring will open under a 750 lb of force. Ring ref A is spread making it easier to use. Ring (Ref B) is not spread, and is preferred for some livestock procedures.

Code	Category	Description	Count	Case
4999-1022-003	Fastening Ring	Ring Fastener LG 1.75 in	1	
4999-1022-005	Fastening Ring	Ring Fastener Tight 1.75 in	1	1

Z

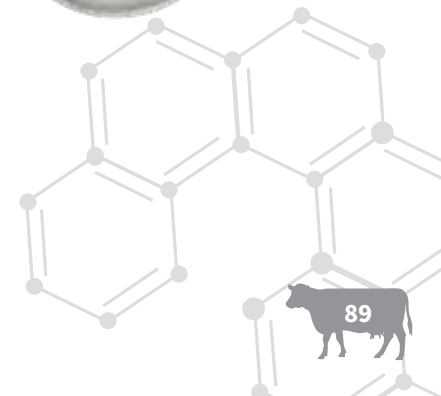

Handling & ID (cont.)

AA

Weightbands

Weightband for determining the weight of cattle and swine. This 250 cm long, tear-proof belt measures in cm. The tape's reverse side contains two tables: one for girth and corresponding slaughter weight (swine), and one for live weight of fat stock and normal stock (cattle). The tape coils up automatically with a push button into a plastic casing. Color of casing may vary.

Item No.	Description	Case Ct.
TA970	Combi Weight Tape/Kg	12

Dairy cattle Weight Tape offer a quick and easy way to determine weight, thereby making it easier to calculate dosages for medications, feed portions, and various other tasks. Instructions provided on each weightband.

Item No.	Description	Case Ct.
TA9102	Weight Tape Dairy Cattle Kg	12

AA



TA970



TA9102

BB

Hand Counter

Hand Counter is lightweight and durable. Designed to fit comfortably in the palm of your hand. Convenient metal ring slides onto finger for a stable grip. Nickel-plated.

Item No.	Description	Case Ct.
7003	Hand Counter	12

BB



CC

Cow Trainer

Cow Trainer with galvanized points. Sold in packages of five trainers with safety hanger and ridged vinyl magic clip used to adjust height of trainer.

Code	Category	Description	Count	Case
4999-1110-504	Clamp	Magic Clip for Cow Trainer	10	1
4999-1110-501	Cow Trainer	w/Points (5x) Complete	5	1
4999-1110-503	Cow Trainer	w/Notched Bar (5x) Complete	5	1

CC

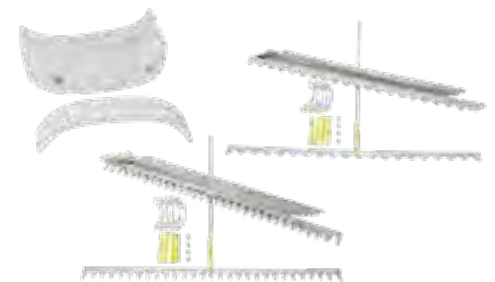

DD

Kick Stop

Fits any size animal by pushing down on the large adjustment button. Very rugged tool made of plated tempered steel. Fits snugly over back for optimum control.

Code	Category	Description	Count	Case
4999-1110-478	Kick Stop	Complete Small Chromed	1	1
4999-1110-482	End-Cap	Rubber for KickStop Large	1	18
4999-1110-483	End-Cap	Rubber for KickStop Small	1	1
4999-1110-481	Spring	Spring with Large Button for Kick Stop	1	18
4999-1110-484	Spring	Spring with Small Button for Kick Stop	1	1

DD

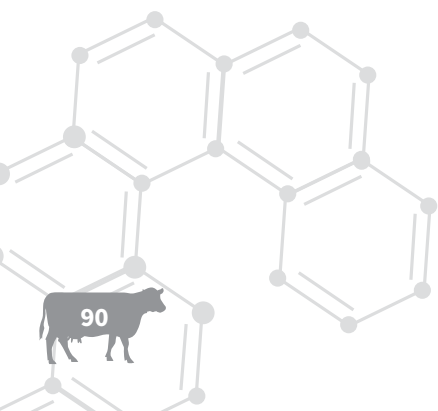



Poly Canes

The original unbreakable livestock cane. Made of tough, ultra-molecular weight polymer. Won't break, crack or straighten out. 39in. long.

Code	Category	Description	Count	Case
4999-1110-620	Cane	Poly Cane Hot Pink 39 in.	1	25
4999-1110-622	Cane	Poly Cane Orange 39 in.	1	25



Cow Collar Nylon

Cow collars are strong and comfortable for the cow. Made of nylon web with heavy-duty hardware. Collars are 1.75in. x 44in. Sold each.

Code	Category	Description	Count	Case
4999-1110-597	Neckband w/ Fastener	Cow Collar Nylon - Black	1	1
4999-1110-598	Neckband w/ Fastener	Cow Collar Nylon - Red	1	1
4999-1110-599	Neckband w/ Fastener	Cow Collar Nylon - Blue	1	1
4999-1114-067	Neckband w/ Fastener	Cow Collar Nylon - Brown	1	1



Neck Strap for Cow Transponder Tags

Direct replacement for Surge® InFARMination style. Straps are 1.5in. x 48in. Black in color.

Code	Category	Description	Count	Case
4999-1110-615	Neckband w/ Fastener	Neck Strap for Transponder	1	1000



Tail Tie

Cow tail ties are used to keep cows cleaner when tied in a stanchion barn for winter. Made of elastic cord with a safety split ring.

Code	Category	Description	Count	Case
4999-1110-500	Tail Holder	Elastic Cord & Split Ring	1	

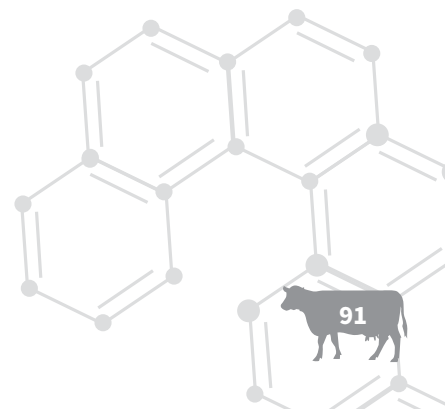
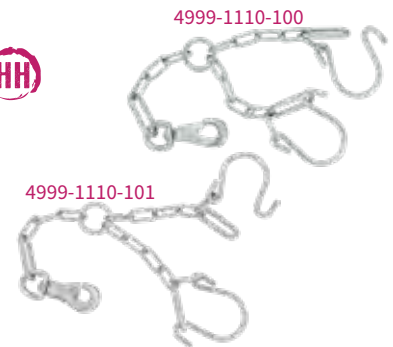

Parlor Supplies

Udder Health • Milk Filters • Towels • Protective Wear & Apparel
Barn Tools • Milk Testing



Parlor Supplies

Udder Health

Did you know?

The sensitive skin on the udder is exposed to environmental changes, including moisture and changing temperatures. Because of this the skin can easily become dry, chapped and sore. Cracks and chaffing can harbor bacteria, decreasing parlor hygiene effectiveness and possibly increasing the chances of mastitis. Neogen's udder care products provide soothing, moisturizing and healing properties of natural mint oils, aloe, lanolin and Vitamin E for cow health and comfort.

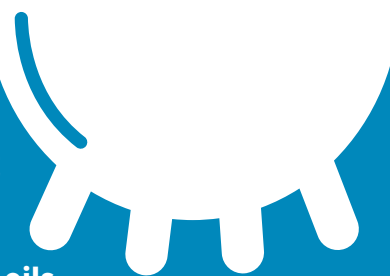

A

Udder Balm

Topical Udder Cream

Udder Balm aids in protection against the effects of extreme weather conditions. Daily application of Udder Balm aids in soothing and softening chapped and irritated skin. Udder Balm is recommended for use on teats, udders, and other skin areas that are exposed to frequent washing and temperature changes.

Item No.	Description	Case Ct.
79247	Udder Balm 4 oz Tube	12
79248	Udder Balm 1 lb	12

A



B

Dynamint Udder Care

Dynamint's action is natural, being a blend of many ingredients recognized for centuries as having therapeutic action. Peppermint oil is a stimulant and fly repellent. Eucalyptus oil is a stimulant and rubefacient. Calendula oil has a softening action, encouraging good, soft, supple skin condition and helps prevent chapping. Tea-tree oil is anti-microbial and acts as a skin cleanser. The emulsion base has moisturizing qualities. The non-greasy, water-based cream is smooth, light and applies quickly and easily.

Code	Description	Count	Case
4999-1179-081	Dynamint Parlor Pak 1 gal Bag	1	25
4999-1179-082	Dynamint Hanger/Teat for 1 gal Bag	1	6
4999-1180-020	Dynamint 500 mL	1	12
4999-1180-022	Dynamint 2 LT/67.6 oz	1	1

B



Udder Health (cont.)

G Kendall Udder Cream

For chapped teats and udders. Aids in the prevention of dryness caused by harsh weather such as excessive wind or sun. Unlike other brands, this formula is absorbed into the skin. Water soluble and non-greasy. Will not contaminate milk. **Approved for U.S. only.**

Code	Description	Count	Case
4999-1180-002	Kendall Cream 28oz	1	12
4999-1180-003	Kendall Cream 4.5lb	1	12



D Udder Comfort Lotion

An all-natural lotion or spray made from a special blend of essential oils to quickly soften and soothe udder swelling. Available in white lotion that dries clear, blue lotion or spray that remains blue from one milking to the next, and yellow spray that “vanishes”. Apply 10mL per quarter after milking.

Code	Description	Count	Case
4999-1179-995	Udder Comfort Spray Yellow 500 mL	1	12
4999-1179-996	Udder Comfort Spray Jug Blue (4 L)	1	2
4999-1179-997	Udder Comfort Spray Blue 500 mL	1	12
4999-1179-998	Udder Comfort Lotion White 300 mL	1	24
4999-1179-999	Udder Comfort Lotion Blue 300 mL	1	24



E Milk Tubes

Ideal's Milk Tubes are brass with a nickel finish, clean-cut eyes, a smooth retaining ball, and are free from burrs.

Item No.	Description
8100	Milk Tubes Adjustable 3.5" 3 pk
8102	Milk Tubes Assorted Fixed Sizes 3 pk
8104	Milk Tubes Fixed 2.5" 3 pk
8105	Milk Tubes Fixed 3" 3 pk



F Teat Bandage

Self-clinging, elastic, soft and doesn't stick to skin or wound.

Item No.	Description	Case Ct.
TA148	Teat Bandage 1 roll/box	96



G Dr. Naylor Teat Dilators

Dr. Naylor teat dilators furnish soft, comfortable protection to injured teat lining, and keeps the teat canal open while the injured tissue heals. Contains no antibiotics. Easy to insert. Stays in the teat. Packed in a special lubricant.

Item No.	Description
DIL	Dr. Naylor Teat Dilators, 40's





Teat Dip Cups

Ensure fresh dip for each cow. Liquid squeezed up into the cup does not siphon back down into the main reservoir, preventing contaminants from flowing into the unused dip. With attached belt hook. Holds approx. 10 fl. oz.

Item No.	Description
TA1915-SYR	Teat Dip Cup Non-Return



Ambic Euro-Style Dip Cups

Ambic's Euro-Style Dip Cup uses less dip. The angled cup, with wide splash-proof lip, allows the user to easily reach all four quarters, yet holds only 0.5oz (15mL) of dip compared to the full 1oz (30mL) capacity of the regular Ambic Non-Return Teat Dippers. Made of tough, durable, chemical resistant material with a wide mouth for easy filling.

Code	Description	Count	Case
4999-1160-536	Euro-Style w/Blue Top	1	132
4999-1160-537	Euro-Style w/Green Top	1	132
4999-1160-529	Replacement Cup	1	528



Ambic Non-Return Dip Cups

The innovative non-return design ensures clean, full strength chemical for your cow's teats. Contaminated chemical cannot get back into the reservoir bottle. Angled top for easier dipping holds 1 oz (30 mL) of dip and allows user to easily reach all four quarters. Made of tough, durable, chemical-resistant materials and features a wide mouth for easy filling.

Code	Description	Count	Case
4999-1160-529	Replacement Cup	1	528
4999-1160-526	Non Return w/Blue Top	1	528
4999-1160-527	Non Return w/Green Top	1	528
4999-1160-528	Non Return w/Orange Top	1	528



Ambic Dip Cups Returning

An indispensable tool for pre and post dipping. Angled cup with wide splash proof lid makes it easy to reach all four quarters. Made of tough, durable, chemical-resistant materials with a wide mouth for easy filling.

Code	Description	Count	Case
4999-1160-533	Returning Blue Top	1	528
4999-1160-534	Returning Orange Top	1	528
4999-1160-529	Replacement Cup	1	528



Foaming Dip Cup

This 30mL multi-foamer Foaming Dip Cup is designed for fast, easy and accurate application of foaming teat disinfectants. Easy squeeze action for rapid and consistent foam generation. Built-in valve protection system with filtered air supply to prevent clogging. Unique system of foaming meshes for optimum foam consistency. Easy to dismantle for fast cleaning.

Code	Description	Count	Case
4999-1160-538	Foaming Dip Cup Blue	1	132
4999-1160-549	Foaming Dip Cup Green	1	132



Udder Health (cont.)

M RJB Dip Cup

A non-return cup designed to handle thick teat dips. Virtually spill proof, the cup becomes a natural extension of your hand. Gentle pressure on the bottle dispenses a small amount of teat dip. Convenient angle top with belt hook. Top Dipper reference 1, Side Dipper reference 2.

Code	Description	Count	Case
4999-1160-540	RJB Top Dipper w/Blue Top	1	300
4999-1160-541	Bottle for RJB Side/Top Dipper	1	400
4999-1160-548	RJB Side Dipper w/Clear Top	1	36
4999-1160-550	RJB Top Dipper w/Green Top	1	150
4999-1160-563	RJB Side Dipper w/Blue Top	1	150
4999-1160-564	RJB Side Dipper w/Green Top	1	40
4999-1160-566	Replacement Teat Guide (Top Clear)	1	100

M



4999-1160-550 4999-1160-563

N Teat Tumor Extractor

Teat Tumor Extractor is Hugs style with polished chrome, which allow for easy and rapid removal of calculi formations. The extractor has been an industry standard for over 20 years.

Item No.	Description
8303	Teat Tumor Extractor Hugs Type

N



O Udder Infusion Cannula

Ideal's Udder Infusion Cannulas are made of nickel-finished brass with a square needle hub.

Item No.	Description
1367	Udder Infusion Cannula 2.5" 3 pk
1369	Udder Infusion Cannula 3.75" 3 pk

O



P DipMizer

Ambic DipMizer dip saver is a snap on disk with bristles which removes excess dip with every application. Saves dip and ensures uniform application. Easily taken apart for cleaning.

Code	Description	Count	Case
4999-1160-521	DipMizer Ring & Brush Blue (3x)	3	100
4999-1160-522	DipMizer Ring & Brush Green (3x)	3	100
4999-1160-524	DipMizer Ring & Brush Orange (3x)	3	100
4999-1160-573	DipMizer Brush Only (5x)	5	50

P



Q Sani-Sure Dipper

Heavy duty plastic dipper holds teat dip in its hollow handle. Easy to use. Convenient built-in cup hooks onto belt, pail, etc.

Code	Description	Count	Case
4999-1160-545	Sani-Sure Dipper White Plastic	1	100

Q





Teat Dip Sprayer - Stainless Steel Tip

A popular hand operated teat sprayer with the stainless steel tip angled up, covering the whole teat quickly and efficiently. Convenient 16oz bottle fits into teat spray holster. Extended model is 4in. (10cm) longer.

Code	Description	Count	Case
4999-1160-551	Teat Sprayer w/ Extended Tip Complete	1	1
4999-1160-553	Repl Extended Tip for Teat Sprayer	1	1
4999-1160-554	Short Blue Tip for Teat Sprayer	1	100
4999-1160-556	16oz Bottle for Teat Sprayer	1	100
4999-1160-559	Teat Sprayer w/White Trig. & Blue Tip Complete	1	1
4999-1160-560	Repl Trigger Assy White	1	6400



The Thrifty Dipper 150

Paints teats from upper chamber providing 100% teat coverage. Dip comes directly to fill the brushes through channels in the upper chamber. Low Maintenance. Post Dipper: has larger channels for higher viscosity dips, and brush that will allow milked out teats to pass through. Pre dipper has smaller channels for light viscosity dips and brush that will last longer for teats full of milk.

Code	Description	Count	Case
4999-1160-630	Dipping Cup Thrifty w/Wiper (White Brush)	1	
4999-1160-631	Brush for Thrifty Dipper Wiper Blue	1	
4999-1160-632	Snap Ring for Thrifty Dipper	1	
4999-1160-633	Thrifty Dipper Wiper Red	1	
4999-1160-634	Thrifty Dipper	1	
4999-1160-635	Wire for Thrifty Dipper	1	
4999-1160-636	Dipping Cup for Thrifty 150 Post-Dip Red	1	
4999-1160-637	Dipping Cup for Thrifty 150 Pre-Dip Blue	1	



WinterSet Powdered Frost Healant

During the winter season the teat surface of dairy animals is subject to added exposure especially when liquid teat dips are used. Liquid teat dips can cause chapping and freezing of the teat. WinterSet is an effective frost and tissue healant with a germicidal agent that reduces bacteria and causes cells involved in healing to migrate more rapidly toward wounds. This powdered product is composed of all natural food grade ingredients with both bactericidal and healing qualities. **Approved for U.S. only.**

Code	Description	Count	Case
4999-1186-095	WinterSet, Powdered 5lb	1	12
4999-1186-097	WinterSet, Powdered 30lb	1	1



Quarter Milker RJB

For isolating one quarter of the cow's milk from the other three quarters, in cases of observed evidence of high somatic cell counts in one quarter. When used as directed, a QMI can significantly lower the SCC in the bulk milk tank which can help yield higher milk premiums.

Code	Category	Description	Count	Case
4999-1090-900	Quarter Milking Device	RJB w/Handle, Complete	1	24
4999-1090-901	Lid	for RJB Quarter Milker	1	1
4999-1100-011	Silicone Hose	26 in for Quarter Milker	1	100
4999-1090-902	Stainless Steel Elbow w/ Vent	SS for RJB Quarter Milker	1	35



4999-1090-900



Milk Filters

A Wall Mount Filter Dispenser

Made of 22 gauge polished stainless steel. Dispensers have easy front loading access. The vertical mount has a hinged door and magnetic catch that closes securely. The horizontal mount has spring loaded access door and can be mounted vertically or horizontally.

Code	Category	Description	Count	Case
4999-1041-035	Filter Dispenser	SS for 4.875in. x 36in. Horizontal Mount	1	1
4999-1041-037	Filter Dispenser	SS Vertical for 3 x 24 filters	1	1

A



B Filter-Clean Disk and Rolls

Designed strictly for gravity applications with an emphasis on speed and capacity. The isotropic filter disc is a product of extensive research to help you increase quality milk production.

Code	Category	Description	Unit	Count	Case
4999-1041-125	Milk Filter	for Clean 12in. x 200ft Roll	PC	1 roll	6 roll/case
4999-1041-120	Milk Filter Disk	FilterCleanDisk 6.5in.	PC	100/box	36 box/case, 1008 box/pallet
4999-1041-121	Milk Filter Disk	FilterClean Disk 9.5in.	PC	100/box	5 box/case
4999-1041-122	Milk Filter Disk	FilterClean Disk 4.5625in.	PC	200/box	18 box/case, 720 box/pallet
4999-1041-123	Milk Filter Disk	FilterClean Disk 12.5in.	PC	100/box	10 box/case
4999-1041-124	Milk Filter Disk	FilterClean Disk 15in.	PC	100/box	10 box/case, 120 box/pallet

B



C Milk Check Filters

Milk Check Filters work better because of better filtration. The micro sized pores in the fabric used are evenly distributed to provide superior filtration. Made of a polyester fabric called "Reemay" which provides a very high wet strength. All the seams are sonically "welded". This eliminates the glue strip and needle holes. Milk Check filters do not contain any resin or glue. All sizes packed 4 boxes per case.

Code	Category	Description	Unit	Count
4999-1041-073	Milk Filter Sock	Milk Check 2.25 x 12	PC	200
4999-1041-074	Milk Filter Sock	Milk Check 2 x 24	PC	200
4999-1041-075	Milk Filter Sock	Milk Check 2.25 x 24	PC	200
4999-1041-077	Milk Filter Sock	Milk Check 3 x 23.375	PC	200
4999-1041-078	Milk Filter Sock	Milk Check 4.875 x 33.5	PC	150
4999-1041-079	Milk Filter Tube	Milk Check 4.875 x 17	PC	150

C





KenAg Break Proof Socks and Tubes

Break Proof filters are designed to be used in moderate to high pressure pipeline milking systems. Exclusive Break Proof fabric provides unsurpassed sock strength, superior sediment retention and optimum flow rate.

Code	Category	Description	Unit	Count	Case
4999-1041-002	Milk Filter Sock	Milk Filter Sock D576 2 x 24in. 100/bx	PC	100/box	6 box/case, 216 box/pallet
4999-1041-003	Milk Filter Sock	Milk Filter Sock D579 2.25 x 12in.	PC	100/box	12 box/case, 480 box/pallet
4999-1041-004	Milk Filter Sock	Milk Filter Sock D577 2.25 x 24in.	PC	100/box	6 box/case, 216 box/pallet
4999-1041-005	Milk Filter Sock	Milk Filter Sock D572 3 x 23.375in.	PC	100/box	6 box/case, 210 box/pallet
4999-1041-006	Milk Filter Sock	Milk Filter Sock D546 4.875 x 17in.	PC	50/box	10 box/case, 300 box/pallet
4999-1041-007	Milk Filter Sock	Milk Filter Sock D548 4.875 x 33.5in.	PC	50/box	9 box/case, 180 box/pallet
4999-1043-035	Milk Filter Sock	Milk Filter Sock D569 5 x 20in.	CS	12 x 100	12 cases/pallet
4999-1041-001	Milk Filter Tube	Milk Filter Tube D539 4.875 x 36in.	PC	50/box	9 box/case, 180 box/pallet
4999-1041-008	Milk Filter Tube	Milk Filter Tube D547 4.875 x 17in.	PC	50/box	10 box/case, 300 box/pallet
4999-1041-009	Milk Filter Tube	Milk Filter Tube D538 4.875 x 33.5in.	PC	50/box	9 box/case, 180 box/pallet
4999-1043-036	Milk Filter Tube	Milk Filter Tube D545 9.125 x 33.25in.	CS	6 x 50	20 cases/pallet
4999-1041-030	Milk Filter Tube	Milk Filter Tube Dairymaster D534 6"x26" 10x50/bx	CS	10x50/box	15 cases/pallet



KenAg Disk and Specialty Filters

Specialized filter fabric made to use in the milk line under vacuum pressure. Provides optimum sediment retention and flow rate without contributing to critical pressure fluctuations in the milking system.

Code	Category	Description	Unit	Count	Case
4999-1041-023	Milk Filter	Milk Filter Non-Gauze Fabric D609 12in. x 200ft Roll Each	PC	1 roll	6 box/case, 120 rolls/pallet
4999-1041-025	Milk Filter	Milk Filter In-Line Square D521 6.5in.	PC	100/box	36 box/case, 1260 box/pallet
4999-1041-019	Milk Filter Disk	Milk Filter Disk D506 4.5625in.	PC	100/box	36 box/case, 1296 box/pallet
4999-1041-020	Milk Filter Disk	Milk Filter Disk D110 6.5in.	PC	100/box	36 box/case, 1260 box/pallet
4999-1041-021	Milk Filter Disk	Milk Filter Disk D531 12.5in.	PC	100/box	10 box/case, 200 boxes/pallet
4999-1041-022	Milk Filter Disk	Milk Filter Disk D532 15in.	PC	100/box	10 box/case, 200 boxes/pallet
4999-1041-024	Milk Filter Sock	Milk Filter Sock PFD D570 3.5 x 14in.	PC	100/box	12 box/case, 300 boxes/pallet



Milk Filters (cont.)

E Ultra Flow Low Pressure Socks

For extremely low pressure or vacuum pipeline systems. Special filter fabric formulation provides the needed level of filtration and flow rate to accommodate low pressure conditions.

Code	Category	Description	Unit	Count	Case
4999-1041-018	Milk Filter Sock	Milk Filter Sock UF LP D568 2.25 x 24in.	PC	100/box	12 box/case, 240 box/ pallet
4999-1043-016	Milk Filter Sock	Milk Filter Sock UF LP D550 2.25"x5.5" 12x100/bx/cs	CS	12x100/ box	50 cases/ pallet

E



F Ultra Flow Tubes and Socks

For moderate to high pressure pipeline systems. Highly effective, cost-efficient solutions for situations where equipment does not require filters designed for extra high pressure performance.

Code	Category	Description	Unit	Count	Case
4999-1041-010	Milk Filter Sock	Milk Filter Sock UF D588 2 x 24in.	100/ box	PC	6 box/case 216 boxes/ pallet
4999-1041-011	Milk Filter Sock	Milk Filter Sock UF D584 2.25 x 12in.	100/ box	PC	12 box/case 480 boxes/ pallet
4999-1041-012	Milk Filter Sock	Milk Filter Sock UF D589 2.25 x 24in.	100/ box	PC	6 box/case 216 boxes/ pallet
4999-1041-013	Milk Filter Sock	Milk Filter Sock UF D590 2.5 x 24in	100/ box	PC	6 box/case 35 cases/ pallet
4999-1041-014	Milk Filter Sock	Milk Filter Sock UF D591 2.75 x 23.5in.	100/ box	PC	6 box/case 210 boxes/ pallet
4999-1041-015	Milk Filter Tube	Milk Filter Tube UF D522 3.25 x 22in.	100/ box	PC	10 box/case 150 boxes/ pallet

F



G Tuffy Perfect-Fit System

The perfect-fit system consists of a stainless steel coil, a rubber retainer and a Perfect-Fit filter fitting securely around the coil, thus eliminating the problem of excess filter media which can lead to voids, breakage and lack of uniform filtration.

Code	Category	Description	Unit	Count	Case Count
4999-1041-135	Milk Filter Sock	Perfect-Fit 24in.	PC	100	8 box/case, 320 box/pallet
4999-1041-130	Spring	Perfect-Fit 24in. x 1.5in. clamp	PC	1	
4999-1041-132	Spring	Perfect-Fit 24in. x 1.5in. w/Surge	PC	1	

G





Tuffy Socks

Multi-purpose, non-woven material designed to have the strength, speed and capacity to function efficiently in vacuum, gravity and low or high-pressure pipeline installations.

Code	Category	Description	Unit	Count	Case
4999-1041-100	Milk Filter Sock	Tuffy 2.25 x 6in.	PC	100/box	10 box/case
4999-1041-101	Milk Filter Sock	Tuffy 2.25 x 12in.	PC	100/box	12 box/case, 540 box/pallet
4999-1041-102	Milk Filter Sock	Tuffy 2.75 x 23.5in.	PC	100/box	5 box/case, 225 box/pallet
4999-1041-103	Milk Filter Sock	Tuffy 3 x 23.5in.	PC	100/box	5 box/case, 225 box/pallet
4999-1041-104	Milk Filter Sock	Tuffy 2 x 24in.	PC	100/box	6 box/case, 270 box/pallet
4999-1041-105	Milk Filter Sock	Tuffy 2.25 x 24in.	PC	100/box	6 box/case, 270 box/pallet
4999-1041-106	Milk Filter Sock	Tuffy 4.875 x 28in.	PC	50/box	9 box/case, 162 box/pallet
4999-1041-107	Milk Filter Sock	Tuffy 4.875 x 33.5in.	PC	50/box	9 box/case, 162 box/pallet
4999-1041-113	Milk Filter Sock	Tuffy 4.875 x 17in.	PC	50/box	9 box/case, 324 box/pallet



Tuffy Tubes

Designed to remove fine sediment, without loss of wet strength or flow rate, to the end of the milking. Function efficiently in vacuum, gravity and low or high-pressure pipeline installations.

Code	Category	Description	Unit	Count	Case
4999-1041-109	Milk Filter Tube	Tuffy 4.875 x 33.5in.	PC	50	9 box/case, 18 box/pallet
4999-1041-110	Milk Filter Tube	Tuffy 4.875 x 36in.	PC	50/box	9 box/case, 162 box/pallet
4999-1041-111	Milk Filter Tube	Tuffy 4.875 x 17in.	PC	50	9 box/case, 36 box/pallet
4999-1041-112	Milk Filter Tube	Tuffy 3.3125 x 22.25in.	PC	100/box	5 box/case, 225 box/pallet



Towels

A Dairy Wipe, Center Pull, Roll Towel

Udderly Fresh dairy towels are extremely soft, strong and absorbent. Made of DRC material that is biodegradable. Blue or tan color allows operator to see dirt and mastitis easier. Towel fits tork dispenser. Each sheet is 9.5in. x 10in.

Code	Description	Count	Pallet
4999-1042-508	Dairy Wipe CP Tan (cs/4 rolls)	4 rolls	40
4999-1042-512	Center Pull Blue (cs/4 rolls)	4 rolls	50



B HD Wiper Towel

General-purpose wiper with good performance in a wide range of cleaning tasks. Easily absorbs liquids, lubricants, and oils yet soft enough for use on hands.

Code	Description	Count
4999-1042-006	HD Wiper Towel 16.4 x 9.8in.	9 x 100



C Bay West 25A

Natural double-layered towel (not shown).

Code	Description	Towel Size	Count	Pallet
4999-1042-025	Bay West 25A natural white	9 x 10in. (22.9 x 25.4cm.)	2250 towels (150 x 15)	60/ pallet



D Pre-dip DARI-TOWL (Bay West #34A)

Single-use towel. A clean towel for each cow reduces the possibility of infectious mastitis spreading through your herd. Soft and absorbent for fast, thorough drying after pre-dipping.

Code	Description	Towel Size	Count	Pallet
4999-1042-034	BayWest 34A natural (2680x)	9 x 10in. (22.9 x 25.4cm.)	2680 towels (268 x 10)	72/ pallet



E Pre-dip Towels (Bay West #47010)

Service-grade brown towels. Single fold for use in dispensers. A quality towel at a lower price.

Code	Description	Towel Size	Count	Pallet
4999-1042-471	BayWest 47010 Natural (4000x)	9 x 10in. (22.9 x 25.4cm.)	4000 towels (250 x 16)	60/ pallet



F Paper Towels Sani-Prep®

Ideal for all phases of the milking operation. Perf-embossed finish adds softness and absorbency for better drying. The portable pop-up dispenser box makes this towel convenient and easy to use. Disposable to aid in disease control.

Code	Description	Towel Size	Count	Pallet
4999-1042-500	Response 21600 White	9.25 x 10.25in. (23.5 x 26cm.)	2400 towels (200 x 12)	70/ pallet
4999-1042-772	SaniPrep1772 White (1980x)	9 x 10.25in. (22.9 x 26cm.)	1980 towels (110 x 18)	36/ pallet



4999-1042-500

4999-1042-772



Windshield Wiper Towel

This 2-ply blue windshield towel has been adapted for use by commercial dairy farms for years. The towel is embossed which improves absorbency and softness.

Code	Description	Count	Pallet
4999-1042-035	Interstate 035 Blue	9.25 x 10.25in. (23.5 x 26cm.)	2250 towels 45/ pallet
4999-1042-502	Response 21800 Blue	9.25 x 10.25in. (23.5 x 26cm.)	2016 towels 60/ pallet



4999-1042-035



4999-1042-502



Plastic Towel Dispenser

An economical and durable plastic paper towel dispenser. Made of hi-impact white plastic and mounts on wall. Front loading design for use with most single fold towels used on dairy farms. Furnished with lock and key.

Code	Description	Count	Case
4999-1041-049	White Plastic Front Loading Dispenser	1	6



Stainless Steel Towel Dispenser

A good quality front loading stainless steel towel dispenser. Mounts on wall and holds most sizes of single fold paper towels used on dairy farms.

Code	Description	Count	Case
4999-1041-056	SS Wall Mount Front Load Dispenser	1	1



Iodine Teat Wipes

Pre-moistened cellulose towel containing 0.5% iodine. Towel is 8 x 10in. and comes packed 1000 per pail or refill. Pail is white, 2gal size with a handle.

Approved for U.S. only.

Code	Description	Count	Case
4999-1041-082	Iodine Teat Wipe	2 x 1000	



Protective Wear & Apparel

Techno Boots

Techno Boots Troya polyurethane boots offer superior comfort, durability, cost savings and safety. Designed for long and intensive use.

- Resistant to oils, fats, manure, acid and chemicals
- Elastopan polyurethane from BASF material make the boots lightweight and thermally insulating. It also provides flexibility and strength.
- Up to 35% lighter than PVCs or rubber boots
- Superior comfort guaranteed
- 3-4 times more durable than PVC or rubber boots due to the abrasion-resistant outer sole
- Memory foam insole which takes the shape of your foot
 - Anti-bacterial
 - Anti-static
 - Washable and fast-drying
 - Odor-resistant
- Kick-off Spur - Boots are easily removable
- Exceptional grip in extreme environments avoids slips and falls

A Safety Techno Boot with Steel Toe

Item No.	Description	Case Ct.
377630	Safety Techno Boot with Steel Toe Size US 5	5
377647	Safety Techno Boot with Steel Toe Size US 6	5
377654	Safety Techno Boot with Steel Toe Size US 7	5
377661	Safety Techno Boot with Steel Toe Size US 8	5
377678	Safety Techno Boot with Steel Toe Size US 9	5
377685	Safety Techno Boot with Steel Toe Size US 10	5
377692	Safety Techno Boot with Steel Toe Size US 11	5
377708	Safety Techno Boot with Steel Toe Size US 12	5
377715	Safety Techno Boot with Steel Toe Size US 13	5
377722	Safety Techno Boot with Steel Toe Size US 14	5
377739	Safety Techno Boot with Steel Toe Size US 15	5



B Non-Safety Techno Boot

Item No.	Description	Case Ct.
377746	Non-Safety Techno Boot Size US 5	5
377753	Non-Safety Techno Boot Size US 6	5
377760	Non-Safety Techno Boot Size US 7	5
377777	Non-Safety Techno Boot Size US 8	5
377784	Non-Safety Techno Boot Size US 9	5
377791	Non-Safety Techno Boot Size US 10	5
377807	Non-Safety Techno Boot Size US 11	5
377814	Non-Safety Techno Boot Size US 12	5
377821	Non-Safety Techno Boot Size US 13	5
377838	Non-Safety Techno Boot Size US 14	5
377845	Non-Safety Techno Boot Size US 15	5



Developed for protective and sanitary use in farm and industrial applications, Neogen's disposable boots are dependable and economical. Whether used on the farm or in the processing plant, Neogen disposable boots are of the highest quality and meet the needs of the most demanding user.

C Elastic Band Boot

An economical disposable boot designed for protective and sanitary use in farm and industrial operations, the disposable boot is 15" tall and available in 2.0, 3.0, 4.0, and 6.0 mil thicknesses. The boot has an elastic band sealed at the top for easy application and better protection. Available in two sizes, medium/large (up to shoe size 12) and extra large (up to shoe size 16). Boots are packaged in bags of 50 boots (25 pair).

Item No.	Description	Case Ct.
BC300	Boot w/Elastic Band 3.0 mil M/L 25 pair	10
BC300-XL	Boot w/Elastic Band 3.0 mil XL 25 pair	10
BC400	Boot w/Elastic Band 4.0 mil M/L 25 pair	10
BC400-XL	Boot w/Elastic Band 4.0 mil XL 25 pair	10
BC600-XL	Boot w/Elastic Band 6.0 mil XL 25 pair	8



D MaxiBoot

Developed for protective and sanitary use in farm and industrial applications, the disposable MaxiBoot is made from a dark brown blended polymer film. It is available in 4.0 mil (heavy duty) film thickness. The calf length boot is extra tall (18") and is available in two sizes: medium/large (up to shoe size 11) and extra large (up to shoe size 14). The MaxiBoot has a unique press-tab fastener closure. Boots are packaged in resealable plastic bags of 50 boots (25 pair).

Item No.	Description	Case Ct.
MT400-XL	MaxiBoot 4.0 mil XL 25 pair	8



E PolyBoot

Designed for use in farm and industrial applications, the disposable PolyBoot is available in 3.0 mil film thickness and is 18" tall. This calf length boot is available in one size, medium/large, is shaped to fit a wide range of shoe sizes and features press-tab fasteners. Boots are packaged in resealable plastic bags of 50 boots (25 pair).

Item No.	Description	Case Ct.
BT300	PolyBoot 3 mil M/L 25 pair	12



F Polyethylene Overboot

Clear plastic disposable over-the-shoe boots with tie closure. Easy to slip on and off.

Item No.	Description	Case Ct.
TA719	Polyethylene Overboots 3 mil 5 pair	10
TA724	Polyethylene Overboots 3 mil 50 pair	10
TA723	Polyethylene Overboots 4 mil 25 pair	10



Protective Wear & Apparel (cont.)



Elastic Top Boots, Disposable

Elastic top boot has a quick apply, no tie design for easy on, easy off convenient protection. Elastic top stretches wide to accommodate large work boots. Durable, lightweight and disposable. Heavy-duty 3 mil plastic, approximately 19.5in. tall.

Code	Description	Count	Case
4999-1170-078	Disposable 3mm 15 in Tall XL	25 pair	



Black Over-The-Shoe Work Rubbers

Black over-the-shoe work rubber has reinforced heel and toe, designed to stand up to tough daily wear. Injection molded for 100% waterproof protection. Excellent tensile strength, ease of stretch and tear resistance. Will not crack or stiffen in cold weather. Heavy duty heel kick-off cleat for easy no hands removal. No lining for easy cleaning. Covers work shoe up to the ankle. Cleated outsole.

Code	Description	Count	Case
4999-1170-531	Black Work Rubber N	1	12
4999-1170-532	Black Work Rubbers L	1	12
4999-1170-533	Black Work Rubbers XL	1	12
4999-1170-534	Black Work Rubbers XXL	1	12



Ultra-Lightweight Boot

Built for comfort, these boots are 70% lighter than other waterproof rubber and PVC knee boots. With 100% seamless waterproof construction, and tiny air bubbles that self-insulate, keeping feet warmer in the cold and cooler in the heat. Great low temperature properties for flexibility and durability. Cleated outsole design for good traction. Lightweight, removable polyurethane contour insole completes the comfort experience.

Code	Description	Count	Case
4999-6003-036	Ultra Lightweight Boot Size 12	1	12
4999-6003-037	Ultra Lightweight Boot Size 11	1	12
4999-6003-038	Ultra Lightweight Boot Size 10	1	12
4999-6003-039	Ultra Lightweight Boot Size 7	1	12
4999-6003-040	Ultra Lightweight Boot Size 8	1	12
4999-6003-041	Ultra Lightweight Boot Size 9	1	12





PVC Knee Boot

Better Grade PVC over-the-sock knee boot is durable on the outside and comfortable on the inside. Injection molded for 100% waterproof protection. Flexible upper material stays supple in cold temperatures to make walking easier. Outsole material is soft for excellent slip resistance and absorbs shock when walking. Cleated outsole spits out debris for excellent gripping action. Removable polypropylene insole wicks perspiration to help keep feet dry and comfortable. Brown upper with crepe sole.

Code	Description	Count	Case
4999-1170-549	15in. PlainT PVC Size 5	1	12
4999-1170-550	15in. PlainT PVC Size 6	1	12
4999-1170-551	15in. PlainT PVC Size 7	1	12
4999-1170-552	15in. PlainT PVC Size 8	1	12
4999-1170-553	15in. PlainT PVC Size 9	1	12
4999-1170-554	15in. PlainT PVC Size 10	1	12
4999-1170-555	15in. PlainT PVC Size 11	1	12
4999-1170-556	15in. PlainT PVC Size 12	1	12
4999-1170-557	15in. PlainT PVC Size 13	1	12



Black 10in. Over-The-Shoe Boot

Black 10in. Over-The-Shoe knee boot has reinforced heel and toe, designed to stand up to tough daily wear. Injection molded for 100% waterproof protection. Excellent tensile strength, ease of stretch and tear resistance. Will not crack or stiffen in cold weather. Heavy duty heel kick-off cleat for easy no hands removal. No lining for easy cleaning. Molded in button for secure closure. Cleated outsole.

Code	Description	Count	Case
4999-1170-521	10in. M	1	12
4999-1170-522	10in. L	1	12
4999-1170-523	10in. XL	1	12
4999-1170-524	10in. XXL	1	12
4999-1170-525	10in. XXXL	1	12



Black 17in. Over-The-Shoe Boot

17in. high, Over-The-Shoe Boot constructed of heavy Flex-O-Thane PVC and a 4-way cleated, slip resistant outsole with full opening gusset. Fits over most work shoes and boots and provides a kick off lug for easy on and off.

Code	Description	Count	Case
4999-1170-235	Viking 17in. Size L	1	12
4999-1170-237	Viking 17in. Size XL	1	12
4999-1170-239	Viking 17in. Size XXL	1	12



Protective Wear & Apparel (cont.)

Neogen gloves are available in vinyl, latex, and the ever-popular nitrile styles. These gloves provide superior protection, durability and sensitivity at an affordable price. Most gloves have a fully textured palm and fingers, allowing a strong grip for both wet and dry applications. Powdered and powder-free versions available in most styles.



Blue Nitrile Gloves

Our nitrile gloves are 100% latex free. Fully textured palm and fingers allow a strong grip for both wet and dry applications. They provide superior puncture, tear and chemical resistance with excellent tactile sensitivity and dexterity. Gloves are powder-free and ambidextrous, with a thickness of 4.0 mil and length of 9". Packs of 10.

Item No.	Description	Case Ct.
3132	Blue Nitrile Gloves M 10/pk	24
3120	Blue Nitrile Gloves L 10/pk	24
3122	Blue Nitrile Gloves XL 10/pk	24



Latex Gloves

Ideal's powder-free latex gloves provide superior protection at an affordable price. Gloves are 4.0 mil in thickness and are available in four sizes. 100 per box.

Item No.	Description	Case Ct.
AT300PF-S	Latex Gloves Powder-Free S 100/bx	10
AT300PF-M	Latex Gloves Powder-Free M 100/bx	10
AT300PF-L	Latex Gloves Powder-Free L 100/bx	10
AT300PF-XL	Latex Gloves Powder-Free XL 100/bx	10



TrueBlack Premium Nitrile Gloves

Ideal's TrueBlack Premium Nitrile Gloves provide strength and durability for extended use and increased hand protection. Gloves are 5.0 mil in thickness in the palm, 5.5 mil in thickness in the fingertip, and have a textured finish. Available in four sizes. 100 per box.

Item No.	Description	Case Ct.
AT455-S	Nitrile Gloves Black S 100/bx**	10
AT450-M	TrueBlack Premium Nitrile Gloves M 100/bx	10
AT450-L	TrueBlack Premium Nitrile Gloves L 100/bx	10
AT450-XL	TrueBlack Premium Nitrile Gloves XL 100/bx	10

** = Not TrueBlack branded





TrueBlue Premium Powder-Free Nitrile Gloves

Ideal's TrueBlue Premium Powder-Free Nitrile Gloves provide superior protection, durability and sensitivity at an affordable price. Gloves are 4.0 mil in thickness in the palm, 4.5 in the fingertip and have a textured finish. Available in four sizes. 100 per box.

Item No.	Description	Case Ct.
CB400-S	TrueBlue Premium Powder-Free Nitrile Gloves S 100/bx	10
CB400-M	TrueBlue Premium Powder-Free Nitrile Gloves M 100/bx	10
CB400-L	TrueBlue Premium Powder-Free Nitrile Gloves L 100/bx	10
CB400-XL	TrueBlue Premium Powder-Free Nitrile Gloves XL 100/bx	10



GlovesPlus

This 5mL powder free black glove offers 20% thicker protection than many standard blue nitrile gloves. Textured for non-slip wet or dry gripping power.

Code	Description	Unit	Count	Case Count
4999-1171-858	GlovesPlus Black XXL	Box	100 Gloves	10 Boxes



Gloveworks Milking Gloves - Blue Textured

A 100% nitrile milking powdered glove that is a hit with many dairymen! Gloveworks are premium, industrial grade gloves with superb tensile strength and a beaded cuff for all tough applications, 5mL thick. Textured for a non-slip gripping power in wet or dry environments.

Code	Description	Unit	Count	Case Count
4999-1169-850	Gloveworks S 100/box	Box	100 gloves	10 boxes
4999-1169-851	Gloveworks M 100/box	Box	100 gloves	10 boxes
4999-1169-852	Gloveworks L 100/box	Box	100 gloves	10 boxes
4999-1169-853	Gloveworks XL 100/box	Box	100 gloves	10 boxes
4999-1169-854	Gloveworks XXL 100/box	Box	100 gloves	10 boxes



N-Dex Nitrile Glove - Blue

These 4 mil blue gloves are better for milking than latex or vinyl gloves. Provides more comfort with superior touch sensitivity and puncture resistance. Protects both cow and operator.

Code	Description	Unit	Count	Case Count
4999-1170-051	N-Dex S 6-7	Box	100 gloves	20
4999-1170-052	N-Dex M 7-8	Box	100 gloves	20
4999-1170-053	N-Dex L 8-9	Box	100 gloves	20
4999-1170-054	N-Dex XL 9-10	Box	100 gloves	20



SemperGuard Nitrile Gloves

Powder free with micro-rough textured surface. Made of synthetic nitrile rubber, non-sterile, blue color with 9in. beaded cuff, 3mL thick. Boxes are color coded by size.

Code	Description	Unit	Count	Case Count
4999-1169-980	SemperGuard Nitrile Powder Free S	Box	100	10
4999-1169-981	SemperGuard Nitrile Powder Free M	Box	100	10
4999-1169-982	SemperGuard Nitrile Powder Free L	Box	100	10
4999-1169-983	SemperGuard Nitrile Powder Free XL	Box	90	10



Protective Wear & Apparel (cont.)



Touch-N-Tuff Powder Free

Touch-N-Tuff gloves are made of 100% nitrile, 5mL thick. They are comfortable to wear due to a special designed glove mold. Protects both the cow and operator. Gloves are green, not textured.

Code	Description	Unit	Count	Case Count
4999-1170-031	T-N-T Powder Free S	Box	100 gloves	10
4999-1170-032	T-N-T Powder Free M	Box	100 gloves	10
4999-1170-033	T-N-T Powder Free L	Box	100 gloves	10
4999-1170-034	T-N-T Powder Free XL	Box	100 gloves	10



Cold Weather Work Gloves

Durable cotton back and genuine pigskin, lined with Heatkeep®, the same lining used in ski gloves. Pigskin leather “breathes” so it dries soft when it gets wet and is tougher than cowhide. Knit wrist to keep out the cold.

Code	Description	Count	Case
4999-1169-943	Cold Weather Work Gloves Med	1	12
4999-1169-944	Pigskin w/Knit Cuff L	1	12
4999-1169-945	Pigskin w/Knit Cuff XL	1	12



Neoprene Gloves

Neoprene flock lined gloves are noted for having resistance to most chemicals like, acids, alcohols, animal fats, caustics, salts, petroleum solvents, detergents and ketones. Gloves are blue, 28mL thick, with anti-slip grip on palm and fingers, 1 pair per/bag.

Code	Description	Unit	Count	Case Count
4999-1170-071	Neoprene M Size 8	Pair	1 pair	24
4999-1170-072	Neoprene L Size 9	Pair	1 pair	24



Milker Sleeves Neoprene

This reinforced neoprene milker sleeve is 18in. long with overlapped elastic cuff on both ends. Neoprene is light weight with excellent protection against chemicals, snags, punctures and abrasions Sold by the pair.

Code	Description	Count	Case
4999-1170-068	Neoprene Sleeves Yellow 18in. (pair)	1	1



Milker Sleeves

Milker sleeves offer low cost protection for operator’s arms. All seams are completely dialectically welded to eliminate leaks. Sleeves are blue, 8mm thick, 18in. long with elastic band on both ends. Packed 24 sleeves per bag.

Code	Description	Count	Case
4999-1170-080	Milker Sleeves Blue	24	1





Milker Sleeves Nylon

This milking sleeve has elastic and velcro closures on the top and bottom so you can adjust for a perfect fit. Made of durable, water-repellent black nylon. Sold one each.

Code	Description	Count	Case
4999-1170-079	Milker Sleeves Black Nylon	1	12



Milker Sleeves with Thumb

Milker Sleeves keep wrists dry and protects from irritation! The sleeve is size X-Large and extends around the thumb to anchor the sleeve. When worn with a glove, it prevents water, dip, and debris from getting inside the sleeve and irritating the skin. Features elastic and velcro at the top of the sleeve to offer a perfect fit around the upper arm. Made of waterproof nylon. Sold one each.

Code	Description	Count	Case
4999-1170-088	Waterproof Nylon Milker Sleeve with Thumb Hole XL	1	1



Protective Wear & Apparel (cont.)

Designed for veterinarian use when performing large animal procedures, Ideal's veterinary apparel is made from a urethane coated nylon oxford material. The garments are navy blue in color, highly water resistant, breathable and machine washable. Custom sizes of all garments may be special ordered.



PolyApron

Designed for durable protection of clothing when treating or grooming large and small animals, the disposable Ideal PolyApron is made from blue heavyweight 4.5 mil polyethylene film. Available in one size (28"x46"), the apron has extra-long ties for ease of tying in front. PolyApron is packaged and sealed in a polyethylene sleeve containing 10 aprons. One size fits all.

Item No.	Description
A450	Vet Apron 10/pk



Blue Dairy Apron

For use on the farm or around the home, the Ideal Blue Dairy Apron comes with an adjustable neck strap and ties in the back. One size fits all.

Item No.	Description
TA1858	Blue Dairy Apron



Cloth Towel Apron

This waterproof apron provides options for one large pocket for towels with two smaller utility pockets on the chest for syringes and medicine, 2 large pockets with a holster between for teat dip or other items or plain without pockets. The straps crisscross and buckle in the back allowing the weight to be carried by the shoulders, not the neck. Each pocket holds approximately 25 towels.

Code	Description	Count	Case
4999-1170-001	Black Nylon 45in. L x 33.5in. W 2 Large Pocket	1	12
4999-1041-043	Black Nylon 45in. L x 33.5in. W 1 Large Pocket	1	12
4999-1041-178	Apron, Waterproof Nylon, Black	1	12



Cloth Towel Half Apron

This half apron has two large pockets for cloth towels. Each pocket holds approximately 25 towels. Belt and buckle attached. Made of water resistant nylon.

Code	Description	Count	Case
4999-1041-054	Cloth Towel Half Apron	1	12



Disposable Apron

A versatile, lightweight vinyl apron ideal for use in warmer climates. Vinyl combines the benefits of flexibility and resistance to chemicals, fats, oils, grease, punctures and abrasion.

Code	Description	Count	Case
4999-1170-026	Disposable Apron (Bag of 12)	12	1





Heavy-Duty Dairy Apron

This heavy-duty long life apron is made of two layers, polyvinyl outside, laminated to a nylon taffeta lining. Features a bib pocket, adjustable neck and waist straps with easy open/close side release buckles.

Code	Description	Count	Case
4999-1170-002	Heavy Duty Poly 30 x 42 Blue	1	12
4999-1170-003	Heavy Duty Poly 30 x 42 Green	1	12
4999-1170-004	Heavy Duty Poly 34 x 48 Green	1	12
4999-1170-010	Heavy Duty Poly 34 x 48 Blue	1	12



Hycar Apron

Made of a rugged fabric reinforced nitrile blend. Ideal for use with grease and animal fats in cold conditions. Comes with attached extra-long neck and waist ties for immediate use. Plastic tips prevent fraying. All aprons are medium weight.

Code	Description	Count	Case
4999-1170-020	Hycar Apron Yellow	1	12
4999-1170-021	Hycar Apron White	1	12
4999-1170-022	Hycar Apron Black	1	12
4999-1170-023	Hycar Apron Maroon	1	12



Towel Tote™ Apron

This apron has a towel tote built in. It holds about 200 paper towels. It also includes two large pockets for dirty towels or other items such as cattle markers, leg bands, inflation plugs and medicine. Apron is made of waterproof nylon.

Code	Description	Count	Case
4999-1041-042	Black Nylon 45in. L x 33.5in W	1	12



Cloth Towel Pouch

You can wear one or two pouches that slide freely onto a belt. Use one pouch for clean towels, one for dirty towels or both for clean towels. The pouch has 2in. reinforced webbing around the top so it will keep it's shape. No reinforced top on the garbage bag. Made of water resistant polyester. Belt sold separately.

Code	Description	Count	Case
4999-1041-063	Pouch 12 x 12 x 6 in for Cloth Towels	1	12
4999-1041-175	Cloth Towel for Garbage	1	12
4999-1041-059	1in. Belt w/Buckle	1	12



Teat Sprayer Holster

The Teat Sprayer Holster is made of white plastic with a belt loop for 16oz bottles. Fits most dip cups.

Code	Description	Count	Case
4999-1160-546	Teat Sprayer Holster	1	12



Protective Wear & Apparel (cont.)



Towel Totes

Tote dispenses single-fold towels one at a time and includes a belt and two straps for hanging teat dippers. Made of durable, water-repellent, black nylon. 6in. H x 9.5in. W.

Code	Description	Count	Case
4999-1041-045	Small Holds 80 Towels	1	12
4999-1041-046	Medium Holds 180 Towels	1	12
4999-1041-047	Large Holds 250 Towels	1	12



Penetone Protective Cream 311

Aids in repelling various acids, alkalis and other skin irritants contained in water solutions. It is almost neutral in pH. Water resistant. Contains lanolin, skin conditioner and skin protectants.

Code	Description	Count	Case
4999-1161-033	Penetone Hand cream 7.1oz	1	24



Barn Tools



Barn Equipment Snaps

All sizes and types of snaps are sold by the box of 10.

Code	Category	Description	Count	Case
4999-1029-054	Snap - Spring Hook	Bolt w/Swivel Eye 1.125in.	10	1
4999-1029-067	Snap - Spring Hook	Bull HD w/Swivel Eye 1 x 5in.	10	1
4999-1029-089	Snap - Spring Hook	Bull w/Swivel 0.875 x 4 in.	10	1
4999-1029-076	Quick Link Ring	0.125 x 1.1875in. Plated	10	1
4999-1029-077	Quick Link Ring	0.1875 x 1.5625in. Plated	10	1
4999-1029-078	Quick Link Ring	0.25 x 1.8125in. Plated	10	1
4999-1029-079	Quick Link Ring	0.3125 x 2.25in. Plated	10	1
4999-1029-080	Quick Link Ring	0.375 x 2.4375in. Plated	10	1
4999-1029-081	Snap - Spring Hook	Plated 0.25 x 2.375in.	10	1
4999-1029-084	Snap - Spring Hook	Plated 0.4375 x 4.75in.	10	1
4999-1029-182	Snap - Spring Hook, Plated	0.3125 x 3.125in.	10	1
4999-1029-183	Snap - Spring Hook, Plated	0.375 x 3.5625in.	10	1
4999-1029-185	Snap - Spring Hook, SS	0.25 x 2.375in.	10	1



4999-1029-081 4999-1029-076



Code	Category	Description	Count	Case
4999-1110-105	Snap Closure	Push In Heavy-duty	1	1

4999-1110-105



Rubber Rope

Black rubber rope 200 ft. of 5/16 in. diameter on a plain cardboard spool.

Code	Category	Description	Count	Case
4999-1100-150	Rubber Cord	0.3125in. Rubber Rope (200ft/60m)	1	7





Cold Roll Steel Crimping Sleeves

Sleeve makes permanent loop with 0.3125in. diameter rubber rope.

Code	Category	Description	Count	Case
4999-1100-160	Sleeve	Crimp for Rubber Rope	50	1



Con-Korite Plus

Concrete patching material that is fast setting, high strength, chemical resistant, tough bonding and can be applied to damp concrete. Excellent for farm use. Con-Korite Plus is a unique combination of a cement-based compound and an acrylic additive which forms this unbeatable, superior patching material. Uses: slats, manger floors, feed bunks, setting posts, gutter walls, parlor and barn floors, steps and curbs. Sets in 10-15 minutes, accepts livestock in 4 hours and is resistant to most farm chemicals and animal wastes. Long wearing surface, 22 sq. ft. at 0.25in. thick. No cracking or peeling when properly applied. Includes 60lbs of Con-Korite mortar and one 2qt bottle of acrylic additive KB25.

Code	Category	Description	Count	Case
4999-1119-010	Concrete Mortar	Con-Korite Plus Kit 60lb	1	1



Dairy Barn Cart

Specifically designed for the dairy barn, this functional utility cart will save you steps and allow you to get your milking chores done quicker and easier. Four wheeled cart holds up to 3 pails. Plastic covered top hooks will carry up to 8 pipeline milking units. Non-corrosive, heavy-duty plastic wheel hubs. Includes strip-cup holders and towel dispenser bracket. Gray and black lacquered finish. Sturdy and efficient. Can be shipped by UPS.

Code	Category	Description	Count	Case
4999-1110-134	Hub	Hub Barn Cart (pk/2)	2	1
4999-1110-138	Wheel	Small Wheel for Dairy Barn Cart	1	1
4999-1110-139	Wheel	Large Wheel for Dairy Barn Cart	1	1



Duct Tape

Polyethylene coated cloth, available in several colors. Used for color coding and vinyl repair. Standard grade. 1.87in. x 60yds (180ft)

Code	Category	Description	Count	Case
4999-1110-605	Tape	Duct Tape, Blue	1	144
4999-1110-606	Tape	Duct Tape, Yellow	1	144
4999-1110-607	Tape	Duct Tape, Red	1	144
4999-1110-608	Tape	Duct Tape, Green	1	144
4999-1112-008	Tape	Duct Tape, White	1	144



Economy Soap Dispenser

Popular dispenser holds 30oz of soap. Refillable with clear plastic tank allowing for visual level inspection.

Code	Category	Description	Count	Case
4999-1160-231	Soap Dispenser	Economy Soap Dispenser	1	1



Barn Tools (cont.)

H Fluid Film Aerosol

Hundreds of uses around the farm and home. Fluid Film is an environmentally friendly, non-toxic, long lasting, penetrant, lubricant, and corrosion preventative. Its formulation has been used for over 50 years in highly corrosive marine environment of ships and off-shore drilling rigs. Use this superior product on milk stall hinges, cylinder shafts or any place where lubricant is needed.

Code	Category	Description	Count	Case
4999-1110-700	Anticorrosive Agent	Fluid Film Aerosol 11.75oz	1	12
4999-1110-710	Anticorrosive Agent	Fluid Film Liquid 1g	1	4



I Grain Scoop

Poly grain scoop with wood handle and poly D grip.

Code	Category	Description	Count	Case
4999-1112-011	Shovel	Grain Scoop	1	3



J Utility Scoop

A quality scoop for almost any material, from feed to powdered detergent. Clear plastic with beveled front edge for maximum pickup, hanging slot for storage and thumb indent for comfort and control.

Code	Category	Description	Count	Case
4999-1110-267	Scoop	Utility Scoop Clear Plastic 32oz	1	12



K Measuring Cup

Chemical resistant, ideal for measuring CIP solutions. Cup indicates liquid and dry material in both ounces and milliliters.

Code	Category	Description	Count	Case
4999-1110-235	Measuring Cup	Measuring Cup 16oz/480mL	1	12
4999-1110-236	Measuring Cup	Measuring Cup 32oz/1L	1	12
4999-1110-237	Measuring Cup	Measuring Cup 64oz/2L	1	12
4999-1110-238	Measuring Cup	Measuring Cup 128oz/4L	1	12



L Milking Stool

A wooden seat with a spring bottom metallic foot. Nylon safety harness with snap-on lock keeps stool in place. 11.75in. tall.

Code	Category	Description	Count	Case
4999-1114-001	Milking Stool	Milking Stool Metallic Spring Foot	1	





Pail Lid Opener

Designed to open pail lids without damaging the lid. The opener is 9in. long and comes with a 0.75 and 2in. plug opener on the sides.

Code	Category	Description	Count	Case
4999-1160-005	Wrench	Pail Lid Opener Nylon	1	144



Two-Way Drum Wrench

Two-way drum wrench that will fit any gallon drum caps. Made of strong and lightweight fiberglass and nylon material. Fits easily into your back pocket.

Code	Category	Description	Count	Case
4999-1160-043	Wrench	Two-Way Drum Wrench	1	12



Universal Drum Wrench

This wrench fits all round-head/hex-head steel and plastic drum plugs.

Code	Category	Description	Count	Case
4999-1160-001	Wrench	Universal Drum Wrench	1	1



Cow Saver™ Low Profile Shower Head

For parlor holding and drip pen applications. Ready to install retrofit for RainBird™ and other 1.25in. sprayer heads. Recommended spacing is 60in. on center. Water usage is 5 gallon per minute at 50 PSI. Just remove and replace with Cow Saver. Features a stainless steel nozzle and body with a low profile spray pattern and no moving parts. Adaptable to round or square pipe. Benefits include longer life, less cow injury, no replacement parts, cleaner cows with less water and easily replaces existing sprinkler heads.

Code	Category	Description	Count	Case
4999-1001-005	Plug	CowSaver Weld	1	1



Insulated Water Nozzle

Heavy-duty, full size metalized zinc body with insulated molded grip for spraying hot or cold. Solid brass valve stem with permanent adjustment. Male hose threaded for attaching accessories. Rubber head guard to protect threads. Hold down clip for continuous spraying. Rust resistant stainless steel spring.

Code	Category	Description	Count	Case
4999-1110-186	Gilmour - Water Nozzle	Gilmour Water Nozzle	1	12
4999-1110-185	Water Nozzle	Water Nozzle	1	12



4999-1110-186

4999-1110-185



Lonn Sanitizer Nozzle

Spray Nozzle

Code	Category	Description	Count	Case
4999-1160-034	Spray Nozzle	Lonn Sanitizing Spray Nozzle	1	



Barn Tools (cont.)

S

Poly Water Nozzle

Full size durable poly, rustproof pistol grip nozzle with hold-help clip for continuous spraying. Poly valve assembly with fixed nut. Male hose threaded front for accessories. Self-adjusting “duck” packing for a lifetime seal.

Code	Category	Description	Count	Case
4999-1110-207	Water Nozzle	Poly Water Nozzle 474 Farm	1	12

S



T

Water Nozzle with Threaded Front

Full size brass pistol grip nozzle system with permanent adjustment nut and clip for continuous spraying. Self-adjusting “duck” packing for leak proof seal. Rust resistant stainless steel spring. Male threaded front for attaching accessories.

Code	Category	Description	Count	Case
4999-1110-197	Water Nozzle	Water Nozzle	1	12

T



U

Water Saver Nozzle Model R

To save water nothing beats an auto shut-off Lonon nozzle. Made of brass non-corrosive fittings, with rubber bumpers to prevent scratching of equipment. Can be used for cold or hot water up to 150°for The model R nozzle is specifically designed to provide a concentrated pressure stream of water. Overall length is 9 in. with garden hose connection.

Code	Category	Description	Count	Case
4999-1160-045	Nozzle	Water Saver LONN Model R	1	5

U



V

Flexogen Hose

The best hose on the market for cold water use. Made of 6 ply reinforced construction. Remains soft and flexible yet is durable. Garden hose ends are heavy-duty brass with built in gasket. Faucet end has a Flow Guard Plus collar to prevent kinks near faucet.

Code	Category	Description	Count	Case
4999-1110-222	Hose	Flexogen Hose 0.625in. x 25ft	1	12
4999-1110-223	Hose	Flexogen Hose 0.625in. x 50ft	1	12

V



W

High Pressure Hose

A hose for extra heavy use including booster pump use. Double cord reinforced with a burst strength of 300 PSI. Extra heavy-duty crush resistant solid brass couplings, resists kinks and pressure twists. Rugged cover resists abrasions from rough surfaces.

Code	Category	Description	Count	Case
4999-1110-227	Hose	High Pressure Hose 0.75in. ID (25ft/8m)	1	1
4999-1110-228	Hose	High Pressure Hose 0.75in. ID (50ft/15m)	1	1

W



X

Hose Accessories

Filter screen is molded into rubber gasket.

Code	Category	Description	Count	Case
4999-1110-201	Hose Filter, compl.	Hose Filter Gasket (3x)	10	12
4999-1110-199	Y-Piece	Y-Piece Connector	1	15

X



4999-1110-201

4999-1110-199



Hose Cleaning Cable Kit

Specifically designed for efficient cleaning of all hoses in milk processing equipment. Kit includes plastic coated steel 8ft cable with 4in. coupling, wall pull, 0.625in. brush, and 0.5625in. metal burr.

Code	Category	Description	Count	Case
4999-1150-120	Cleaning Pack	Cable Hose Cleaning Kit 3000	1	12



Hose End Repair Kit

Menders are premium construction for maximum strength and durability. Repair ends are a patented impact resistant clamp design, with non-corroding high grade stainless steel screws that will not strip when tightened. Can be used on 0.625in. or 0.75in. rubber or plastic hose.

Code	Category	Description	Count	Case
4999-1110-189	Hose Connector	Female 0.625in.-0.75in. ID	1	12
4999-1110-191	Hose Connector	Male 0.625in.-0.75in. ID	1	12



Hose for Hot Water

This hose is ideal for use on dairies, farms, ranches and construction. Handles water up to 180°F (83°C) with a burst strength of 400 PSI. Full flow brass couplings. Withstands nozzle shut-off. Flexible and kink resistant. With garden hose ends. 0.625in. ID.

Code	Category	Description	Count	Case
4999-1110-230	Hose	Hot Water Hose ID (25ft/8m)	1	12
4999-1110-231	Hose	Hot Water Hose ID (50ft/15m)	1	12



Hose Splicer Repair Kit

The strongest mender available, this coupler is leakproof, reusable and will fit 0.625in. or 0.75in. hose.

Code	Category	Description	Count	Case
4999-1110-187	Hose Union	Hose Splicer 0.625in. - 0.75in. ID	1	12



Sanitizing Hoses / Replacement Sanitizing Hoses

One end female garden hose connector the other end male 0.25in. NPT. All ends are non-corrosive brass. Made of reinforced rubber hose with 0.375in. I.D

Code	Category	Description	Count	Case
4999-1160-038	Hose	Sanitizing 6ft	1	1
4999-1160-039	Hose	Sanitizing 8ft	1	1



Stainless Steel Hose Rack

This high quality, heavy-duty hose rack is the perfect option for your foamer. Holds foamer or wash down hoses. Made of stainless steel rod and will not rust. Comes with convenient mounting bracket for wall or round post.

Code	Category	Description	Count	Case
4999-1160-230	Structural Frame	Stainless Steel Hose Rack	1	1



Barn Tools (cont.)



Tube/Hose Cutter

No route sales person, dealer or dairyman should be without a tube/hose cutter. A fast, safe, efficient way to cut milk and vacuum tubing. Can also be used on rubber, vinyl and thin wall plastic pipe. Cuts clean and square with no ragged edges. Carbon steel blade closes into handle for safety. 0.125in. [3mm] - 1.625in. [42mm]

Code	Category	Description	Count	Case
4999-1090-140	Knife	Hose/Tube Cutter	1	1
4999-1090-141	Blade	Replacement Blade	1	1



Voluspray Wash Down Gun

Heavy-duty brass Voluspray gun provides different spray settings as the gun is twisted from narrow flushing through wide flushing to a wide soaking spray and a focused 13 mm cutting jet to move stubborn dirt. A large rubber buffer gives protection against hard surfaces. Competitively priced and more durable when compared to existing plastic models.

Code	Category	Description	Count	Case
4999-1110-184	Hose Nozzle	Voluspray Gun HD 1in. Barb VS-25in.	1	1
4999-1110-212	Hose	HD Red 1in. x 50ft-15m w/NPSH Ends	1	1



4999-1110-184

4999-1110-212



Wash Down Hoses

Made of reinforced rubber hose and comes with one female end garden hose connector and one male end garden hose connector. All end connectors are made of non-corrosive brass. 200 PSI rated. Rated to 190°F. 5/8in ID

Code	Category	Description	Count	Case
4999-1110-215	Hose	Wash Down Hose 6ft	1	1
4999-1110-216	Hose	Wash Down Hose 10ft	1	1
4999-1110-217	Hose	Wash Down Hose 15ft	1	1
4999-1110-218	Hose	Wash Down Hose 20ft	1	1
4999-1110-219	Hose	Wash Down Hose 25ft	1	1



Economy Sprayer

An economical clear PVC bottle with trigger sprayer. Graduations on side for measuring and mixing.

Code	Category	Description	Count	Case
4999-1110-248	Pistol-Type Sprayer	Economy Sprayer w/Trigger & Bottle 36oz	1	12
4999-1160-562	Spray Head	Replacement Trigger Assy	1	12



Cattle Blaster Trigger Spray Bottle

The Cattle Blaster Trigger sprayer is a high capacity sprayer and bottle for mixing and spraying a variety of solutions around the farm and home. Great for show cattle work. 36oz.

Code	Category	Description	Count	Case
4999-1110-239	Pistol-type Sprayer	Holds 36oz/1L	1	1





Foammaster Foam Cleaning Gun

Foam generating wand creates a thick, clinging foam that accurately mixes and sprays foaming chemicals. Detach handle for a powerful spray rinse. For cleaning, degreasing or disinfecting when a foam is desired to increase surface contact time. Easy-to-fill wide mouth, chemical resistant polyethylene, quart bottle.

Code	Category	Description	Count	Case
4999-1160-229	Foam Gun	Foam Cleaning Gun	1	12



Pump Up Sprayer

This pump up sprayer has a Natural HDPE bottle with a spray head and adjustable nozzle. Heavy-duty metal plunger shaft will not break. Synthetic rubber o-rings and teflon seals increase chemical resistance. Nozzle adjusts from a stream to a fine mist. Wide mouth opening allows for quick refills.

Code	Category	Description	Count	Case
4999-1110-255	Spraying Device, Compl.	Pump Up Sprayer 64oz/2L	1	



Anti-Siphon Stock Tank Valve

An approved design for dairy farms. This anti-siphon stock tank valve delivers up to 300gal per hour of water. Mounts easily in any tank. Standard garden hose connection of 0.75in. pipe connection. Available with metal or hi-impact plastic housing.

Code	Category	Description	Count	Case
4999-1140-018	Float Valve	Plastic Antisiphon Stock Valve Tank	1	1
4999-1140-019	Float Valve	Aluminum Anti-Siphon Stock Tank Valve	1	5



4999-1140-018

4999-1140-019



Hudson Valve Bracket

Hudson valve economy bracket is made of glass filled nylon construction with thumb screw for quick and easy mounting of the Hudson valve to portable tanks and troughs at the end of standard 0.75in. garden hose connection. Includes PVC elbow and 0.75in. adapter.

Code	Category	Description	Count	Case
4999-1140-010	Bracket	Hudson Valve Bracket	1	



Hudson Water Valve

The Hudson valve's unique design operates using a patented float system. The fluid level forces the float to rise and close the diaphragm chamber. The diaphragm then expands to stop the incoming flow. Repair kit contains: retainer ring, control chamber, diaphragm w/ stem and strainer, float, and screen. Use of this valve will restrict G.P.M. by 20%.

Code	Category	Description	Count	Case
4999-1140-003	Diaphragm	Diaphragm w/Stem & Strainer (1)	1	1
4999-1140-002	Repair Kit	Hudson Water Valve All Sizes (2)	1	12



4999-1140-003

4999-1140-002



Jobe™ Topaz Industro Valve

Topaz float valves are used for maintaining water levels in troughs, tanks, cisterns, air conditioning systems, high pressure cleaning systems and irrigation applications. The valve is configured for above or below water mounting. The float operates a small pilot valve which in turn operates the main diaphragm valve. Topaz float valves are compact, robust, and of non-corrosive construction. 5-100 psi range. Flows up to 90 gallons per minute.

Code	Category	Description	Count	Case
4999-1140-014	Float Valve	Jobe Topaz Indust Valve 1in. Detach	1	1



Barn Tools (cont.)



Jobe™ Frostpro

Frostpro is a freeze prevention device that minimizes freezing in cold weather conditions. It is manually operated and when turned on allows a continuous flow of water through the valve to prevent water freezing in the valve or supplying pipeline. For use with Topaz Float Valves. 1in.

Code	Category	Description	Count	Case
4999-1140-022	Float Valve	Jobe Frostpro	1	1



Jobe™ Megaflow Float Valve

Megaflow Float Valves are ideal for filling troughs which are constructed to have the valve mounted under the water; on the side or on the bottom. Its diaphragm principle of operation allows the Megaflow to give flows of up to 90 gallons per minute. The Megaflow is compact, robust and manufactured from non-corroding materials. 5-150 psi range. 0.75in.

Code	Category	Description	Count	Case
4999-1140-023	Float Valve	Jobe Megaflow 0.75in. Detach	1	1



Jobe™ Protect-A-Mount

Quickly and easily attaches to most styles of troughs or tanks (plastic,metal,concrete) with a 2in. air break to eliminate back siphoning, without the use of tools. This durable, UV protected mount protects your 0.75in. Rojo or Topaz Valve from animals and is ideal for pasture or yard installations.

Code	Category	Description	Count	Case
4999-1140-016	Valve Cover	Jobe Protect-A-Mount	1	1



Jobe™ Rojo Float Valve

Rojo Float Valve is float operated with a built-in check valve, used for automatic filling of water storage vessels. The Rojo can be mounted above or below water level with side, bottom and top mounting options. Valve body twists apart by hand for easy servicing, halting the flow. The Rojo features an adjustable float angle, a switch to lock valve in OFF position and is constructed of non-corrosive material. 0-150 psi range. Flows up to 6 gallons per minute. Low pressure model also available, 0-75 psi range gives 60% more flow.

Code	Category	Description	Count	Case
4999-1140-015	Float Valve	Jobe Rojo Float Valve 0.75in.	1	1



Jobe™ Service Kit Topaz/Megaflow

Repair Kit for Topaz and Megaflow Float Valves.

Code	Category	Description	Count	Case
4999-1140-017	Repair Kit	Topaz/Megaflow Valve Repair Kit	1	1



Jobe™ Topaz Float Valve

Topaz float valves are used for maintaining water levels in troughs, tanks, cisterns, air conditioning systems, high pressure cleaning systems and irrigation applications. The valve is configured for above or below water mounting. The float operates a small pilot valve which in turn operates the main diaphragm valve. Topaz float valves are compact, robust, and of non-corrosive construction. 5-100 psi range. Flows up to 90 gallons per minute. 0.75in. fitting.

Code	Category	Description	Count	Case
4999-1140-012	Float Valve	Jobe Topaz 0.75in. Float Valve	1	1





Dairy Chemical Pump

This pump is designed for use in a dairy farm milk house. It comes with three safety features. A threaded twist handle to prevent inadvertent lifting of the handle. A "strap lock" to prevent unauthorized use, and an anti-siphon spout to reduce drippings. Each pump comes with a 2in. standard drum adapter. No warranty on pump once used.

Code	Category	Description	Count	Case
4999-1160-008	Drum Pump	12in. Chemical Pump 6oz/pump	1	25
4999-1160-009	Drum Pump	12in. Chemical Pump 8oz/pump	1	25
4999-1160-010	Drum Pump	12in. Chemical Pump 11oz/pump	1	25
4999-1160-012	Extension	36in. Extension Tube	1	1



Drum Pump with Flex Spout

A self-venting poly pump, turns 360 degrees. Fits standard 0.75in. or 2 in openings. Comes with adapter to fit 5 gal pails with Reike flex spout cap. Extension tubing supplied to fit 15, 30, or 55gal drums.

Code	Category	Description	Count	Case
4999-1161-010	Drum Pump	Drum Pump with Flex 8oz	1	



Drum Pumps

Swivel no-drip nozzle with anti-pumping safety strap

Code	Category	Description	Count	Case
4999-1160-006	Drum Pump	Drum Pump, 5gal-6oz/p	1	1
4999-1160-024	Drum Pump	Drum Pump, 15gal-8oz/p	1	1
4999-1160-025	Drum Pump	Drum Pump, 55gal-14oz/p	1	1



Economy Drum Pumps

Sanitary maintenance pump for detergents, waxes, alkalis and water. Allows easy, directional dispensing of liquids into receiving containers.

Code	Category	Description	Count	Case
4999-1160-021	Drum Pump	MP1218-S Economy Drum Pump	1	25
4999-1160-023	Drum Pump	MP 3630S	1	25



EZI-Action™ Drum Pump Accessories

Repair parts and accessories

Code	Category	Description	Count	Case
4999-1160-029	Measuring Kit	Measuring Kit	1	1
4999-1160-027	Repair Kit	EZI pump 15 & 55gal Repair Kit	1	1
4999-1060-341	Safety Strap	Safety Strap Yellow for EZI Action	1	1



4999-1160-027

4999-1160-029

4999-1160-341



Jug Pump for 1gal

This pump is made to fit 1L/gal containers and dispenses 1oz per stroke. Note: Recommended to remove spring when used with chlorine.

Code	Category	Description	Count	Case
4999-1161-077	Hand Pump	1gal Jug Pump 1oz/pump	1	1



Barn Tools (cont.)



Pail Pump for 5gal (20L) Containers

This pump has a unique non-drip spout. Dispenses 1oz per stroke from a 5 gal container with 2.75in. (70mm) male thread.

Code	Category	Description	Count	Case
4999-1160-014	Hand Pump	BC 06M02 70mm thread	1	1
4999-1160-046	Hand Pump	Pail Pump 5gal 1oz/pump	1	



4999-1160-014



4999-1160-046



Poly Drum Faucet

Faucets are made of chemical resistant polyethylene. Spigot screws directly into a 0.75 in. threaded lid cap and will fit a 5 or 15gal drum.

Code	Category	Description	Count	Case
4999-1160-016	Drain Faucet	Poly Drum Faucet Nonvented	1	1
4999-1160-017	Drain Faucet	Poly Drum Faucet Vented	1	400



4999-1160-016



4999-1160-017



Vented Drum Pump

A high quality lever action poly drum pump. Dispenses 10oz per stroke. Fits 2in. opening and has adjustable extension tube to fit 15, 30 or 55gal drums. Spigot has 360 degree orientation.

Code	Category	Description	Count	Case
4999-1160-020	Drum Pump	Vented Drum Pump MR60-CPM 2in 10oz/p	1	250



Broom/Floor Barn Tools



Barn Broom

Top performance, long lasting, barn broom with plastic bristles. Bristles are securely staple set in hardwood blocks. All broom blocks are sealed on the ends to prevent cracking and splitting. Value priced to provide years of service. Tapered handle sold separately.

Code	Category	Description	Count	Case
4999-1150-068	Broom	Styrene Blue Bristle 3.5 x 16 x 5.25	1	6
4999-1150-075	Broom	Styrene Blue Bristle 3.5 x 16 x 4.25	1	6



4999-1150-068



4999-1150-075



Barn Broom with Poly Bristles

Stiff, long wearing blue bristles are ideal for extra heavy load. Hardwood block. Tapered handle sold separately.

Code	Category	Description	Count	Case
4999-1150-252	Broom	Barn Broom, Poly 3.5 x 24 x 5in.	1	6



Replacement Broom Braces

Code	Category	Description	Count	Case
4999-1150-085	Fastening Brace	Universal for Broom	1	12
4999-1150-086	Fastening Brace	Triangle for Broom	1	12



4999-1150-085



4999-1150-086



Broom Handles

Broom Handle for use with most standard brooms.

Code	Category	Description	Count	Case
4999-1150-100	Broom Handle	48in. Wood w/Metal Thread	1	12
4999-1150-101	Broom Handle	60in. Wood w/Metal Thread	1	12
4999-1150-220	Broom Handle	36in. Fiberglass w/Plastic Thread	1	12
4999-1150-105	Broom Handle	48in. Fiberglass w/Plastic Thread	1	12
4999-1150-106	Broom Handle	60in. Fiberglass w/Plastic Thread	1	12
4999-1150-107	Broom Handle	54in. Tapered Wood	1	12
4999-1150-109	Broom Handle	60in. Tapered Wood	1	12



4999-1150-100

4999-1150-220

4999-1150-107



Milk House Broom

Heavy-duty broom excellent for wet or dry surfaces. Wood handle with plastic bristles.

Code	Category	Description	Count	Case
4999-1150-087	Broom	Milk House Broom with Handle	1	6



Slim Barn Broom

Carries a heavy workload at a moderate price. Hardwood block. Tapered handle sold separately.

Code	Category	Description	Count	Case
4999-1150-070	Broom	Blue Plastic Bristles 2 x 24 x 4.25	1	6
4999-1150-071	Broom	Blue Plastic Bristles 2 x 24 x 5.25	1	12
4999-1150-072	Broom	Brown Plastic Bristles 2 x 24 x 5.25	1	1



4999-1150-070



4999-1150-072



4999-1150-071



Barn Hoe

The livestock barn hoe was developed for the removal of livestock waste between and behind cows or horse stalls or can be used to scrape under farrowing crates. Livestock hoe will get the job done with its 60 degree angled, 12in. blade.

Code	Category	Description	Count	Case
4999-1110-131	Barn Hoe	12in. Poly Blade Complete	1	1
4999-1110-132	Barn Hoe	12in. Stainless Steel Blade Complete	1	12
4999-1110-133	Blade	Replacement Blade	1	1



Barn Hoe & Scraper

Hoe blade has gold baked coating. Blade size is 3in. x 12in. (7.6cm x 30.5cm). White ash handle is 54in. (137.2cm) long. One year warranty.

Code	Category	Description	Count	Case
4999-1112-015	Scraper	Barn Hoe and Scraper	1	3



Barn Hoe Double Sided

Made from durable polypropylene, this two-sided scraper is lightweight with extra scraping surface. The wide side measures 13.75 in. and the narrow side measures 4.625in. The 72in. wood handle provides extra length for those hard to reach areas. Also fits poly canes.

Code	Category	Description	Count	Case
4999-1110-116	Scraper	Poly Double Sided Barn Hoe	1	
4999-1110-117	Handle	Wood 72in. Handle for Poly Scraper	1	



4999-1110-116



4999-1110-117

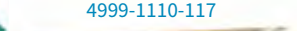

Barn Tools (cont.)

J

Poly General Purpose Shovel

Great for snow, feed or manure. Gray long lasting polypropylene rustproof blade, 46.5in. stained ash handle with poly D grip. Blade dimensions 20in. and 26in. x 13.25in. Overall length 54.5in. Gray in color.

Code	Category	Description	Count	Case
4999-1112-004	Snow pusher	Poly Grizzly Shovel 20in.	1	6
4999-1113-005	Snow pusher	Poly Grizzly 26in.	1	6

Sturdy, rustproof, lightweight shovel. 40in. (102cm) handle with poly D grip. Blade dimensions 13.75in. x 17in. (35cm x 43cm). Overall length 51in. (129cm).

Code	Category	Description	Count	Case
4999-1112-003	Shovel	General purpose poly 13.75 x 17in.	1	6

J

4999-1112-004



4999-1112-005



4999-1112-003

K

Slippery Barn Scraper

Superscrapers have a wide variety of uses, removal of snow, livestock floor accumulation, debris on sidewalks and drive-ways, feed manger uses, as well as factory/commercial uses. Superscrapers are built for comfort, interchangeability and strength. Our curved handle allows for a more comfortable and controlled grip. The handle and tubular braces are made of strong powder-coated steel. All handles and braces are interchangeable on all sizes of floor scrapers. All scrapers shipped unassembled.

Code	Category	Description	Count	Case
4999-1110-120	Manure Scraper	Slippery Barn 24in. Complete	1	1
4999-1110-122	Manure Scraper	Slippery Barn 36in. Complete	1	1
4999-1110-124	Manure Scraper	Slippery Barn 48in. Complete	1	1
4999-1110-121	Blade	10in. x 24in. Scraper Blade	1	1
4999-1110-123	Blade	10in. x 36in. Scraper Blade	1	1
4999-1110-125	Blade	10in. x 48in. Scraper Blade	1	1
4999-1110-127	Repair Kit	Hardware pk for Slippery Scraper	1	1
4999-1110-126	Scraper Handle	Steel Handle w/Grip	1	1
4999-1110-129	Scraper Handle	Wood Handle	1	6

K



L

Squeegee

Blade made of gum rubber. Tapered wood handle sold separately.

Code	Category	Description	Count	Case
4999-1150-090	Squeegee	24in. Squeegee without Handle	1	6

L





Superscraper

Superscrapers have a wide variety of uses, removal of snow, livestock floor accumulation, debris on sidewalks and drive-ways, feed manger uses, as well as factory/commercial uses. Superscrapers are built for comfort, interchangeability and strength. Our curved handle allows for a more comfortable and controlled grip. The handle and tubular braces are made of strong powder-coated steel. All handles and braces are interchangeable on all sizes of floor scrapers. All scrapers shipped unassembled.

Code	Category	Description	Count	Case
4999-1110-140	Manure Scraper	Superscraper 24in. Blade w/60in. Handle Included	1	1
4999-1110-141	Blade	Superscraper 24in. Blade	1	1
4999-1110-147	Blade	Poly Black 9in. x 24in. Blade	1	1
4999-1112-059	Blade	Replacement Big Push 24in. Black Poly Blade	1	1
4999-1110-119	Bolts Set	Set for Superscraper	1	1
4999-1112-054	Scraper Handle	Metal Handle, Yellow	1	1



4999-1110-140



4999-1110-141



Floor Scrub Brush

The original 3 position Hi-Lo is designed to clean in open areas, under equipment or work tables, and base boards. Plastic block uses threaded handles that are sold separately.

Code	Category	Description	Count	Case
4999-1150-096	Brush	Hi-Lo Floor Scrub Brush	1	12



Brushes/Cleaning Barn Tools



Inflation Brush

Designed to machine and inflation specifications. Wire handle covered with a plastic sleeve.

Code	Category	Description	Count	Case
4999-1150-001	Brush	Regular Bore 1.25in. diameter	1	12
4999-1150-002	Brush	Regular Bore with vacuum pocket 1.25in. diameter	1	12
4999-1150-003	Brush	Narrow bore with vacuum pocket. Tapered body 0.9375 - 0.8438in.	1	12



Long Handle Scrub Brush

Hand scrub brushes with 20in. long handle.

Code	Category	Description	Count	Case
4999-1150-046	Brush	20in. Yellow Poly Scrub Brush	1	12
4999-1150-047	Brush	Hercules White 20in. Nylon Scrub Brush	1	12



4999-1150-046



4999-1150-047



Truck & Wall Wash Brush

This brush features soft, flared bristles to cover more cleaning surface. The large 5 in. x 12 in. bristle spread will reach into any corner. Structural foam block with one threaded and one tapered handle hold. Can be used with flow through handle.

Code	Category	Description	Count	Case
4999-1150-137	Brush	Truck Wash 5x12in. w/o Bumper	1	12
4999-1150-254	Brush	Truck Wash 5x12in. w/Bumper	1	12



4999-1150-137



4999-1150-254

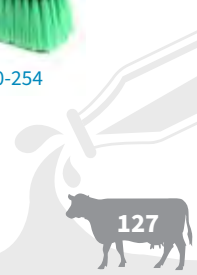

Barn Tools (cont.)

D Brush for Milk Tank & Equipment

Features a solid white plastic head to reduce bacteria build up. All around bristles ensures cleaning action at any angle. Threaded handle sold separately.

Code	Category	Description	Count	Case
4999-1150-015	Brush	Oval Brush for Tank 5.5 x 7.5in.	1	12
4999-1150-017	Brush	Oval Brush for Tank 5.5 x 9in.	1	12



E Brush for Valve, Elbow, Fitting

Straight brush with bristles on wire with a plastic handle. Designed for cleaning valves, tees and elbows.

Code	Category	Description	Count	Case
4999-1150-010	Brush	1.5in. Valve Brush 15in. L	1	1
4999-1150-011	Brush	2in. Valve Brush 15in. L	1	1
4999-1150-012	Brush	2.5in. Valve Brush 15in. L	1	1



F Claw Brush

For cleaning claws, lid, cover tubes and pulsators.

Code	Category	Description	Count	Case
4999-1150-004	Brush	Double End Claw Brush 0.5 x 0.75in.	1	1
4999-1150-005	Brush	Double End Claw Brush 0.5 x 1in.	1	1



G Cylinder Brush

A medium stiff bristled brush that is perfect for valves, outlets, small tanks, cylinders and steam kettles. Bristles are at the head and around the handle.

Code	Category	Description	Count	Case
4999-1150-034	Brush	Cylinder Brush 5 x 16in.	1	12



H Milk Tank Brush Round

A round bristle pattern with a swivel handle attachment makes quick work of scrubbing large tanks. Handle sold separately.

Code	Category	Description	Count	Case
4999-1150-020	Brush	Round Tank Brush 2in.x8in.	1	12
4999-1150-021	Handle	Plastic 42in. Handle	1	12



I Short Handle Scrub Brush

Short handle scrub brushes with 8in. long handle.

Code	Category	Description	Count	Case
4999-1150-043	Brush	8in. White Poly Scrub Brush	1	12
4999-1150-044	Brush	Hercules White 8in. Nylon Scrub Brush	1	12





Swiss Pail Brush

Hand brushes (Swiss pail brush) are used for general purpose close quarter work where larger brushes won't fit.

Code	Category	Description	Count	Case
4999-1150-050	Scrub Brush	White Poly Swiss Pail Brush	1	12



Tanker Brush Jumbo

This jumbo size brush has three threaded handle holes for three-way cleaning action and uniform wear. Solid white plastic block. Handle sold separately. 6in. x 10.5in.

Code	Category	Description	Count	Case
4999-1150-030	Brush	Tanker Brush Jumbo	1	12



Scrubber Scour Pad

These cost effective scrubber scour pads are great to have all around the farm for those quick chore applications. Gentle to the user's hands and safe for glass, sinks, counters, tiles and stainless steel. The 6 x 9in. durable pads rinse clean again and again.

Code	Category	Description	Count	Case
4999-1110-492	Scrubbe Pad	Heavy Duty Green Pads	10	10
4999-1110-494	Scrubbe Pad	Fine Duty White Pads	10	10
4999-1110-522	Scrubbe Pad	Medium Duty Green Pads	10	10



Stainless Steel Sponge

There is no question why this long lasting, non-abrasive, stainless steel sponge is a standard in cleaning stainless steel. The continuous strand spun sponge easily cleans equipment, without corroding or steel impregnation.

Code	Category	Description	Count	Case
4999-1110-520	Sponge	Stainless Steel Sponge	12	1



Hose Cleaning Cable Kit

Specifically designed for efficient cleaning of all hoses in milk processing equipment. Kit includes plastic coated steel 8ft cable with 4in. coupling, wall pull, 0.625in. brush, and 0.5625in. metal burr.

Code	Category	Description	Count	Case
4999-1150-120	Cleaning Pack	Cable Hose Cleaning Kit 3000	1	12



Calf Bottle and Nipple Brush

A special brush designed especially for cleaning calf bottles and nipples. One end for cleaning the bottle, the other for cleaning the nipple. Nylon bristles on a wire handle.

Code	Description	Count	Case
4999-1150-054	Calf Bottle and Nipple Brush	1	12



Calf Bottle Brush

Soft polyester bristles are wound with stainless steel wire. All plastic handle with knurled grip.

Code	Description	Count	Case
4999-1150-053	Calf Bottle Brush	1	12



Milk Testing

A BetaStar® S and Advanced

BetaStar tests are used to detect beta-lactam and tetracyclin antibiotic residues, including amoxicillin, ampicillin, cephapirin, cloxacillin, penicillin, and ceftiofur in raw, commingled milk.

Item No.	Description
602377A	BetaStar S Incubator
BSS050	BetaStar S 50 Tests
BSC050	BetaStar S Combo 50 Tests
9650	Raptor Integrated Analysis Platform
BSA002	BetaStar Advanced for Beta-lactams (100 tests)
BSATET	BetaStar Advanced for Tetracyclin (25 tests)



B California Mastitis Test

The California Mastitis Test (CMT) is a quick, simple way to help predict the somatic cell count of milk from individual quarters or on composite milk samples. Ready to use.

Item No.	Description
TA1842	CMT Test Paddle 4 Sections White
TA1843	CMT Milk Test Liquid 32oz



C Strip Cup Ambic

A plastic strip cup with black plastic screen for detecting mastitis. Screen is easily removed by pushing down on thumb rest.

Code	Category	Description	Count	Case
4999-1180-030	Strip Cup	Blue Plas. w/Black Insert	1	300



D Ambic In-Line Milk Sampler

Sampling of milk gives important information that can help dairy farms be more profitable. Checking individual cow milk for high somatic cell counts is the best way of identifying problem cows. The Ambic sampler is a stand-alone in line sampler that can be used with any brand of milking equipment. It uses vacuum to pull a representative sample from each claw. The sampler comes with an easy on and off rubber connection. When the cow is finished milking, remove the bottle and pour sample into approved vial and re-install sample bottle. Sampler comes complete with body, 200mL collection bottle, plastic mounting bracket, cable tie and instructions. Key Benefits: Takes up to a 200mL sample. Low cost stand-alone milk sampler. Simple cut tubing and fit installation. Maintenance free. Easy to clean, body is designed for CIP cleaning.

Code	Description	Count	Case
4999-1180-119	AMBIC Milk Sampler, Complete	1	350
4999-1180-120	Bottle for Ambic Sampler 200mL	1	1



E Ambic Vision 2000 Mastitis Detector

Guaranteed to find 95% of clinical mastitis. Simple to use and cost effective. Stable vacuum-large bore (0.625 ID, 0.75in. OD). **Approved for U.S. and Canada.**

Code	Category	Description	Count	Case
4999-1180-044	Mastitis Detector	Vision 2000	1	180
4999-1180-045	Mastitis Detector	Vision 2000	4	42
4999-1180-048	Houseing Cover	Replacement Body for Vision 2000	1	100
4999-1180-047	O-Ring	Vision 2000 Mastitis Detector O-Ring	6	1
4999-1180-046	Screen	Vision 2000 Mastitis Detector Screen	2	1





Mas-D-Tec™

Provides a simple, convenient and instantaneous means of detecting subclinical mastitis. MAS-D-TEC measures electrical conductivity in a small sample (2mL) of milk, detecting increases in conductivity long before other clinical symptoms are evident. The unit's electronic circuitry is completely enclosed in a strong, waterproof case for long, dependable service in the milking parlor environment. Designed for handheld operation, it is powered by a standard "9V" battery (included). 1,000's of cows can be tested on a single battery.



Code	Category	Description	Count	Case
4999-1110-796	Mastitis Detector	Mas-D-Tec	1	4



Milk Thermometer

This useful thermometer in a plastic cage helps keep track of milk temperature. A must-have for every dairyman. Ranges -10°C 120°C (not available in Fahrenheit). 13" long.



Item No.	Description
TA1851	Milk Thermometer Celsius

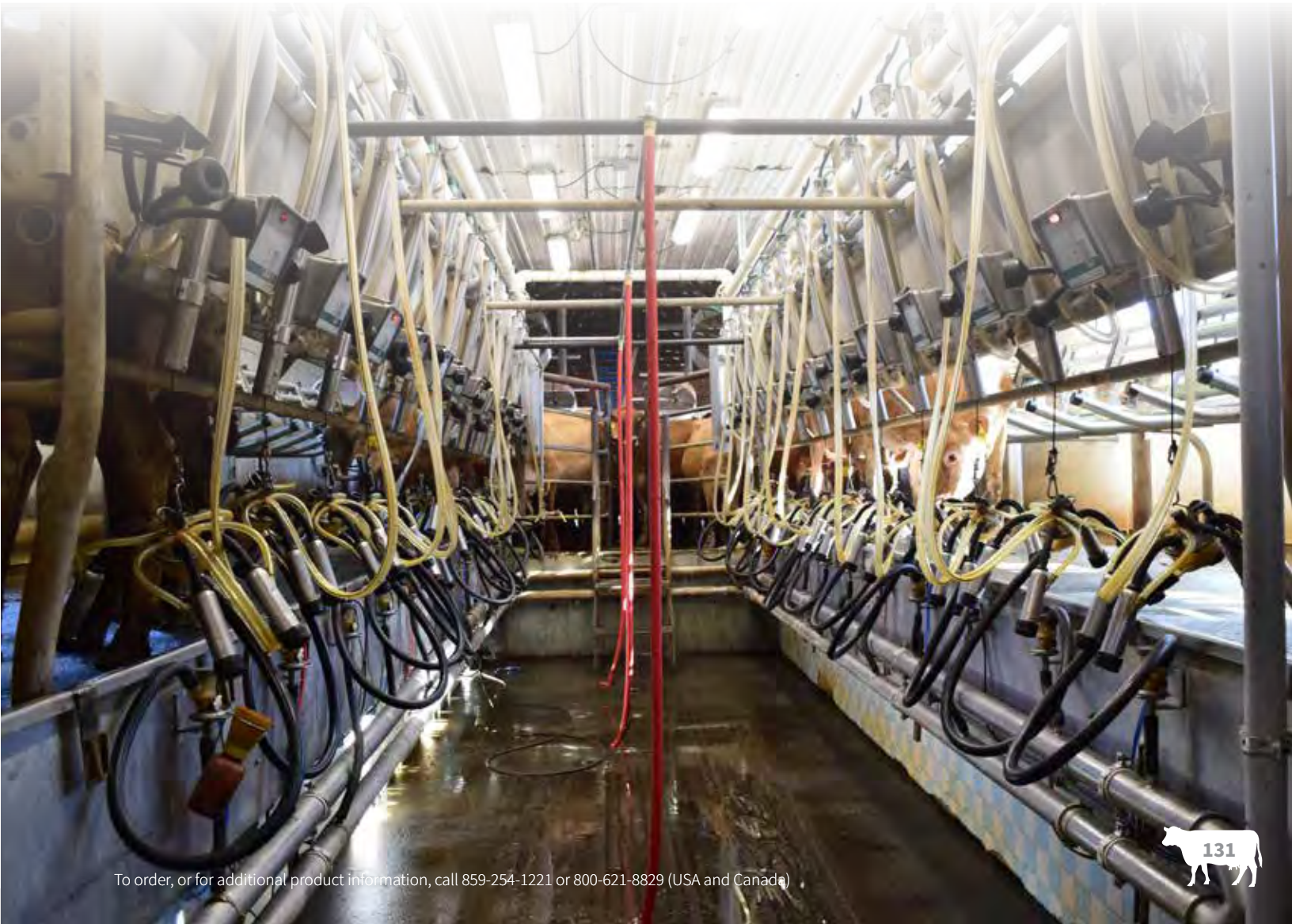

Small Ruminant



Small Ruminant

A

Sheep & Goat Electric Dehorner

Cast bronze electric dehorner with a 5/8" inner diameter. Preferred for dehorning small calves and goats. It only requires a few seconds and there is no blood loss using this dehorner.

Item No.	Description	Case Ct.
2103	Sheep & Goat Electric Dehorner 5/8"	6



WARNING: This product can expose you to the chemicals including lead, which is known to the State of California to cause cancer and birth defects or other reproductive harm. For more information go to www.P65Warnings.ca.gov.

A



B

Controlled Flow Lamb Nipples

Our controlled flow lamb nipples are made of clear isoprene with extremely soft, yet strong walls. The hollow cone tips allow the flow of milk to be regulated from slow to fast. Nipples fit most standard soda bottles.

Item No.	Description	Case Ct.
7007	Nipple Controlled Flow 3pk	24

B



C

Floating Teat

Easy to take apart and clean. Extra-large plate prevents nipple from tipping over.

Item No.	Description	Case Ct.
FW1207	Floating Teat Complete w/Plate	12
FW1207A	Replacement Teats 2/pk	12

C



D

Gum Rubber Lamb Nipples

Ideal's gum rubber nipples will fit most standard soda bottles.

Item No.	Description	Case Ct.
7005	Nipple gum Rubber 3pk	24

D



E

Lamb and Kid Bottle

NEOGEN's Lamb and Kid feeding bottle comes complete with a Red Screw-On Teat and provides an easy way to measure and feed orphan lambs and kids. Measurements on the side of the bottle make it easy to see that each animal is getting the appropriate amount of milk or replacer. Always check temperature of milk or milk replacer before feeding.

Item No.	Description	Case Ct.
7004	16 oz. / 1 pint Bottle	24

E



F

Red Screw-on Ideal® Teats for Lambs and Kids

Lambs and kids quickly learn to nurse when using Ideal® Red Screw-on Teats from Neogen. The nipples are made of soft red latex, which closely resemble the ewe's teat, and screws easily onto the Ideal® Lamb & Kid Bottle as well as most standard soda bottles. Threading on cap prevents leakage and a special flutter valve prevents air intake. Simply use sharp scissors to snip the end of the Red Screw-On Teat to create the appropriate size opening. Wash with warm, soapy water.

Item No.	Description	Case Ct.
7006	Teat, Red Screw-on 2pk	24

F



Small Ruminant

G

Lamb Bucket

Lamb bucket comes complete with three teats, three valves, and a metal hanging bracket. 8 Liters / 2.1gal.

Item No.	Description	Case Ct.
FW1209	Lamb Bucket Complete	6
FW1209A	Lamb Bucket Replacement Teat 6/pk	2

G



H

Lamb Feeder

Two-compartment lamb feeder. 10 Liters / 2.6gal. Complete with six red rubber teats and valves.

Item No.	Description	Case Ct.
FW1213	Lamb Feeder Complete	6
FW1209A	Lamb Bucket Replacement Teat 6/pk	6
FW1205B	Lamb Bucket Spare Valve with Washer	12

H



I

Small Water Bowl

Small PVC plastic drinking bowl equipped with 1/2" brass nipple and valve system. Has a flow valve and nylon frost plug protection. The nose paddle is easily activated by small animals. Ideal for sheep, goats, calves and dogs.

Item No.	Description	Case Ct.
FW1229	Small Water Bowl Plastic	2

I



J

"Black-Blue" Sheep Shears

Finest sheep shears. Made of hardened and tempered steel. Rubber stoppers for smooth shearing. Straight blades.

Item No.	Description	Case Ct.
TA1445	Sheep Shears 11.5" (29cm) Right Hand	12

J



K

B&B Double Bow Sheep Shear

The 6.5" Double Bow Sheep Shear by Burgon & Ball are made from Sheffield steel. The shears have a rolled bow, which creates an easier action and increases overall strength. Heat treatment guarantees hardness and long-term edge retention of blades. Blades are double hollow ground (Hinds patent). Blades and shank are a single piece for increased durability and accuracy. Each shear is handset and tested.

Item No.	Description	Case Ct.
7015	Sheep Shears B&B Double Bow 6.5"	12

K



L

Heart-Shaped Sheep Shears

Made of high quality forged steel.

Item No.	Description	Case Ct.
TA1443	Shears Sheep 10.8" S	12

L





Halogen Lamp

Ideal for piglets, lambs and poultry. High/low switch for power regulation. Cord is 7' 10" long. Holder is 9" in diameter, 15" tall, and made of lightweight aluminum. UL/CSA approved. Conforms to CE norms. Holds one bulb, sold separately. Tests in laboratories have proven long bulb lifetime. Shock and water resistant. Compact and light, storage volumes and breakage are reduced. Conforms to CE norms. Holder is for halogen infrared bulbs from 125 to 250 watts.

Item No.	Description	Case Ct.
TA5000	Halogen Lamp Holder HB-01 Each	6
TA5175	Halogen Bulb Red Brooder 175W Each	6
TA5250	Halogen Bulb Red Brooder 250W Each	6



WARNING: This product can expose you to the chemicals including lead, which is known to the State of California to cause cancer and birth defects or other reproductive harm. For more information go to www.P65Warnings.ca.gov.



B&B Eze-Trim Foot Rot Shears

These super-sharp foot rot shears are made by Burgon & Ball and have non-stick coated, high carbon-steel blades that retain the sharpest edge. Blades have been heat treated to give the optimum combination of strength and hardness. The blade tension can be adjusted and the blades lock in place. Resin handles are both durable and extremely comfortable to use. Shears come with a 5-year manufacturer's guarantee.

Item No.	Description	Case Ct.
7020	Foot Rot Shear B&B Eze Trim	10



Hoof Rot Shears

Ideal Hoof Rot Shears have sharp, pointed double stainless steel blades. The top blade is serrated to cut hooves with ease. Blue powder coated handle. Use to trim cattle, sheep and goat hooves.

Item No.	Description	Case Ct.
9801	Hoof Rot Shears	12
TA900	Hoof Rot Shear w/Holster	6





944 Nandino Blvd. • Lexington, KY 40511

859-254-1221 or 800-621-8829

inform@NEOGEN.com • NEOGEN.com



800-525-2022 (USA/Canada) or 859-254-1221
inform@NEOGEN.com • animalsafety.NEOGEN.com